

European Association
for the Development of
Renewable Energy,
Environment and
Power Quality

RE&PQJ-9

RENEWABLE ENERGY & POWER QUALITY JOURNAL

RE&PQJ-9, ISSN 2172-038X

No.9, 12th May 2011

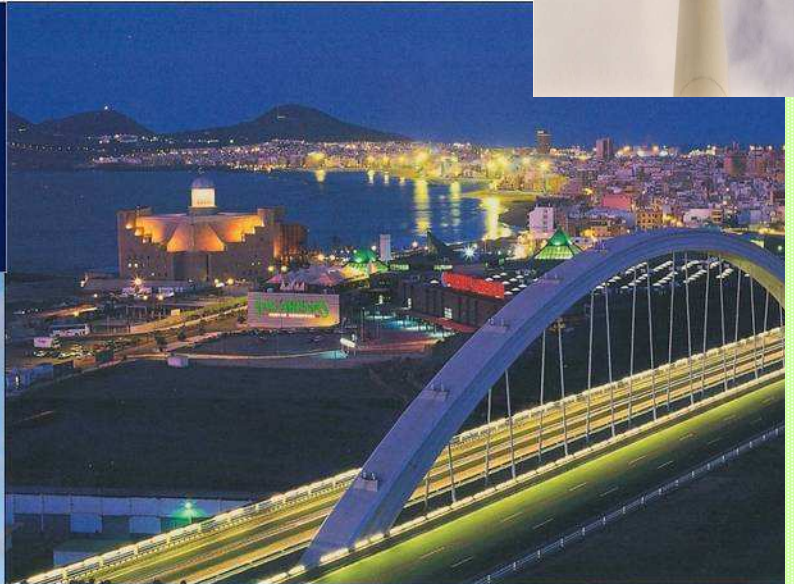
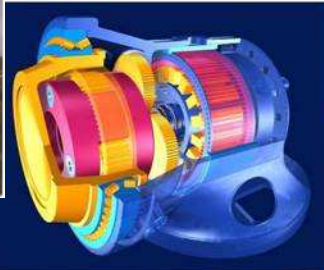

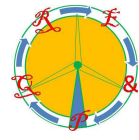

RE&PQJ-9 EDITORIAL COMMITTEE

Manuel Pérez Donsión (Main Editor)
Ramón Bargalló Perpiña
Manuel Burgos Payán
Debora Coll Mayor
Mario Mañana Canteli
Mariano Sanz Badía

RE&PQJ-9 SCIENTIFIC COMMITTEE

Alexandru, Catalin (Romania)	Kádár Péter (Hungary)
Andrada Gascón, P. (Spain)	Kladas, A. (Greece)
Andras, Dan (Hungary)	Lemos Antunes, C. (Portugal)
Arcega Solsona, F. (Spain)	Levi, Emil (U.K.)
Arnaltes Gómez, S. (Spain)	Llombart Estopiñan, A. (Spain)
Bargallo Perpiña, R. (Spain)	Machado e Moura, A. (Portugal)
Basma EL ZEIN (Saudi Arabia)	Mañana-Canteli, M. (Spain)
Bendl, Jiri (Czech Republic)	Martinez, André (France)
Bitzer, Berthold (Germany)	Narsimhulu, Sanke (India)
Boccaletti, Chiara (Italy)	Niememan, Asco (Finland)
Burgos Payan, M. (Spain)	Petkovska, L. (Macedonia)
Brslica, Vit (Czech Republic)	Predescu, Mihai (Romania)
Capolino, G.A. (France)	Redondo Gil, C. (Spain)
Catalão, João (Portugal)	Ribeiro, Hugo (Portugal)
Cortez, Liliana (México)	Robyns Benoit (France)
Driesen, Johan (Belgium)	Roger Folch, J. (Spain)
Donsión, M.P. (Spain)	Rusek, Jan (Poland)
Duran, M. (Spain)	Saadate, S. (France)
Engin Ozdemir (Turkey)	Salmerón-Revuelta, P. (Spain)
Ertan, H.B. (Turkey)	Sanz Badía, M. (Spain)
Fernández Cabanas, M. (Spain)	Shibli, Murad (Arab Emirats)
Figueiredo, J.M.G. (Portugal)	Schlemmer, Erwin (Austria)
Flores, Antonio (Portugal)	Stenzel, Jürgen (Germany)
Fraile Mora, Jesús (Spain)	Stumberger, Gorazd (Slovenia)
Funabashi, Toshihisa (Japan)	Tegopoulos, J.A. (Greece)
Gharehpetian, G.B. (Iran)	Tekwani, P. (India)
Ghita, Constantin (Romania)	Torrente Lujan, E. (Spain)
Göl, Ozdemir (Australia)	Tudorache, Tiberiu (Romania)
Güemes Alonso, J.A. (Spain)	Valouch, V. (Czech Republic)
Iwaszkiewicz, J. (Poland)	Vitale, Gianpaolo (Italy)
Jokinen, T. (Finland)	Zamora Belver, I (Spain)
Jigeng Li (China)	Zobaa Ahmed (UK)
Jyotirmoy Roy (UK)	

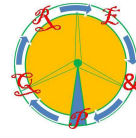

The following papers have been included in the
Renewable Energy & Power Quality Journal

No.9, 12th May 2011

ISSN 2172-038X

Titles/Authors/Institution/Country

209 Modeling and simulation of power yield in chemical and electrochemical systems

S. Sieniutycz, P. Kuran

Faculty of Chemical and Process Engineering, Warsaw University of Technology. Poland

215 Investigation and evaluation of multilevel H-NPC converter for electrically driven trains

G. Adamidis, N. Alagialoglou, G. Tsengenēs

Department of Electrical Engineering and Computer Engineering. Democritus University of Thrace. Greece

217 Development of a small-scale reactor system for bioethanol production from agriculture waste geared towards small industries applications in Malaysia

M.O. Abdullah(1), S.F.Lim(1), S.F.Salleh(1), T.M. Tai(1), S.L. Leo(1), A.K. Umar(2)

1. Faculty of Engineering. University Malaysia Sarawak. Malaysia

2. Sofia Enterprise Asajava, Sadong Jaya. Malaysia

218 Digital fault locator for double end fed transmission lines

Roberto Micheletti

Department of Electrical Systems and Automation, University of Pisa. Italy

220 Improving profitability of the network distribution by protecting power transformers with a current limiting technology device

T. Madiba, M. Siti, A.A. Jimoh

Department of Electrical Engineering, Tshwane University of Technology, Campus of Pretoria. South Africa

226 Assessment of harmonic distortion sources in power networks with capacitor banks

Reyes S. Herrera, Patricio Salmerón, Salvador P. Litrán

Department of Electrical Engineering, E.T.S.I.Huelva University. Spain

227 Study on split-capacitors applied in positive output super-lift Luo-converters

Fang Lin Luo

Nanyang Technological University. Singapore

230 A practical comparative evaluation of different active harmonic filter topologies

Patricio Salmerón, Salvador P. Litrán, Reyes S. Herrera, J. R. Vázquez

Departamento de Ingeniería Eléctrica y Térmica. Escuela Politécnica Superior, University of Huelva. Spain

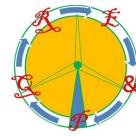

477 Proposal for the use of solar heaters in small residences of Curitiba

Alysson M. Schuindt, Marcus A. Caldeira, Roberto C. Betini

Academic Department of Electrotechnique, Federal Technological University of Paraná. Brazil

478 Energy response of a mono-axis tracked solar thermal collector with vacuum tubes

V.E. Dombi, I. Visa, D.V. Diaconescu, M.M. Vatasescu, N.I. Tatu

Department Renewable Energy Systems and Recycling, Transilvania University of Braşov. Romania

479 Photovoltaic stand-alone power generation system with multilevel inverter

M.I. Desconzi, R.C. Beltrame, C. Rech, L. Schuch, H.L. Hey

Power Electronics and Control Research Group, Federal University of Santa Maria. Brazil

480 Optimization with genetic algorithms of PVT system global efficiency

G. Fabbri(1), M. Greppi(2), M. Lorenzini(1)

1. D.I.E.N.C.A. Dipartimento di Ingegneria Energetica, Nucleare e del Controllo Ambientale. Università degli Studi di Bologna. Italy

2. Università di Bologna Seconda Facoltà di Ingegneria. Italy

483 A single stage DC-DC converter feasible to battery charging from PV panels with high voltage step up capability

Paulo P. Praça, Gustavo A.L. Henn, Ranoyca N.A.L.S., Demercil S. Oliveira, Luiz H.S.C. Barreto
Energy and Control Processing Group- GPEC, Department of Electrical Engineering, Universidade Federal do Ceará. Fortaleza-CE. Brazil

485 Annealing of ZnO and SnO₂ transparent conductive oxides

K. Lagha (1,2), MS Belkaid(1), M. Pasquinelli(2), D. Barakel(2), L. Escoubas(2)

1. Laboratoire des Technologies Avancées du Génie Electrique, Université de Tizi-Ouzou. Algérie

2. Institut Matériaux Microélectronique Nanosciences de Provence IM2NP, Université d' Aix Marseille. France

487 Energy valuing of forest biomass residues in Bizkaia

E. Mateos(1), J.M. González(2), J.M. Eguzkitza(3)

1. Department of Chemical and Environmental Engineering

2. Department of English and German Philology

3. Department of Applied Mathematics. E.U.I.T.I., University of the Basque Country, Bilbao. Spain

488 The wind energy apply to water pumping in isolated place

Juraci Carlos de Castro Nóbrega, Thelmo Silva de Araújo

Department of Electrical Engineering, U.F.A.M. Amazonas University. Brazil

490 Modeling and power control of wind turbine driving DFIG connected to the utility grid

Karim Belmokhtar, Mamadou Lamine Doumbia, Kodjo Agbossou

Département of Electrical and Computer Engineering, Université du Québec à Trois-Rivières. Canada

492 Direct driven axial flux permanent magnet generator for small scale wind power applications

A.P. Ferreira(1), A.F. Costa(2)

1. School of Technology and Management, Polytechnic Institute of Bragança. Portugal

2. Department of Electrical and Computer Engineering, FEUP, Porto. Portugal

Direct Driven Axial Flux Permanent Magnet Generator for Small-Scale Wind Power Applications

A. P. Ferreira¹ and A. F. Costa²

¹ School of Technology and Management, Polytechnic Institute of Bragança
Campus de Santa Apolónia, Apartado 1134, 5301-857 Bragança, Portugal
Phone: +351 273 303 105, Fax: +351 273 313 051, e-mail: apf@ipb.pt

² Department of Electrical and Computer Engineering, FEUP
R. Dr. Roberto Frias, 4200-465 Porto, Portugal
Phone: +351 225 081 872, Fax: +351 225 081 443, e-mail: acosta@fe.up.pt

Abstract. Small-scale wind power applications require a cost effective and mechanically simple generator in order to be a reliable energy source. The use of direct driven generators, instead of geared machines, reduces the number of drive components, which offers the opportunity to reduce costs and increases system reliability and efficiency. For such applications, characterized by low speed of rotation, the axial flux permanent magnet generator is particularly suited, since it can be designed with a large pole number and high torque density.

This paper presents an axial flux permanent magnet synchronous generator, double sided with internal rotor and slotted stators. Such a structure gives a good compromise between performance characteristics and feasibility of construction. The design process of the machine is described and validated by test experiments.

Key words

Wind energy, axial flux, permanent magnet generator, direct driven, design.

1. Introduction

There is currently significant interest in the development of small-scale wind turbines for the urban environment, with both horizontal and vertical axis being considered [1-3]. Small-scale wind turbines are also an attractive choice for autonomous applications and for rural areas where the installation of a distribution grid is not economically reasonable [4].

The power range of those systems is usually about 500 W to 5 kW. Permanent magnet excitation is favoured in this power range, from the point of view that the required volume of permanent magnets is nowadays costly affordable. The main advantages of permanent magnet synchronous generators over wound-rotor generators are due to the fact the first ones do not require any external excitation current, which translates in a significant decrease in rotor losses and also allows the use of a diode

bridge rectifier at the generator terminals, with significant cost benefits in the power converter topology [5-7].

Permanent magnet excitation also allows a significant decrease of the pole pitch, which translates in cost and mass reduction [8]. This assumption together with the axial flux generator configuration favour the use of a direct driven generator (gearless system) because it allows the use of higher pole number [9]. Furthermore, axial flux permanent magnet machines are recognized for having higher torque density than their counterparts based on radial-flux, this being more apparent in a design with a large number of poles.

Axial flux permanent magnet machines may be designed in various configurations [10-12]. A double-sided axial flux permanent magnet synchronous generator with internal rotor intended for small-scale wind energy systems was proposed on [13]. In this paper, the analytical design of the machine is enhanced with finite element analysis (FEA). Experimental test results are carried out.

2. Generator concept

Axial flux machines are characterized by an axially directed airgap flux. The simplest structure uses one stator ring form and a disk rotor (Fig. 1), both having the same active inner and outer diameters which defines the active part of the machine where the electromechanical conversion takes place.



Fig. 1. Single stator-single rotor axial flux machine structure.

The axial length is dependent on the flux density in the stator and rotor yokes. Thus, in opposition to radial flux machines, both stator and rotor yokes can be fully utilized with a proper yoke design. As a consequence, when the number of poles increases the axial flux machine radial active part remains almost unchanged, but the axial length can decrease and the torque density increases. Hence, axial flux machines are particularly suited in low speed, high torque applications such as wind power conversion systems.

A drawback of the single stator-single rotor structure is the unbalanced axial force between the rotor and the stator, which leads to a thicker rotor disk and complex bearing arrangements, this compared to double sided structures, presented in Fig. 2. These structures eliminate the axial forces between permanent magnets and the stator iron with the benefit of increasing the total air gap surface.

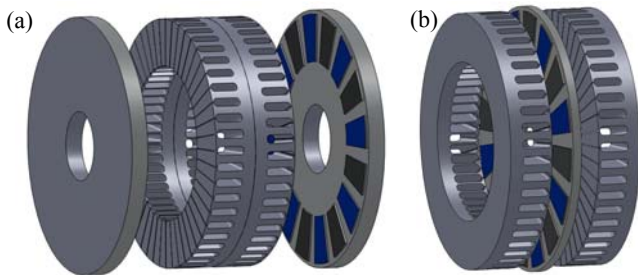

Fig. 2. Double sided axial flux machine structures. (a) internal stator. (b) internal rotor.

The double sided structure with internal rotor (Fig. 2 (b)) simplifies the manufacture process due to easier fixation of the stator rings to the frame; it also favours the cooling process because the main heat source is located near the surface. The axial flux permanent magnet synchronous generator developed is based in structure.

Slotted stators increase remarkably the amplitude of the airgap flux density due to shorter airgap. This reduces the required amount of permanent magnets, which yields savings in the generator price. On the other hand, slotting may evoke undesired torque pulsations, but the adopted structure allows the rotation of one stator over one half of the slot pitch with respect to the other, which results in reduced slot ripple and space harmonic components [14]. Current ripple in slotted stators may also be reduced due to higher leakage inductance compared to slotless stators.

It's currently assumed that concentrated windings are an effective way to reduce Joule losses in low speed

permanent magnet machines [15, 16], due to shorter end windings. However they generate both odd and even harmonics, and some, also produce sub-harmonics in the EMF. All extra harmonics create additional flux in the machine which results in high eddy current losses in a conducting rotor and in the permanent magnets, which may cancel the benefits of the shorter end windings. A conventional distributed winding with one slot per pole and phase is preferred.

The flux path associated with this machine topology is shown in Fig. 3. The flux travels axially in the rotor structure and completes its path by returning circumferentially around the stators cores.

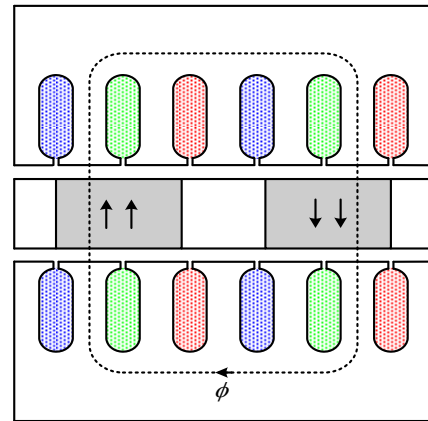

Fig. 3. 2D plane of the axial flux permanent magnet machine.

3. Design procedure

The main dimensions of the machine are achieved iteratively via analytical approach, based on some simplifying assumptions, as described on [13].

The equivalent magnet circuit approach and permanent magnet load line characteristics are used to estimate the magnetic loading, which determines the stator yoke dimensions, and the specifications and dimensions of the magnets. This analytical approach does not lead to exact magnetic field solutions. However it often leads to analytic solutions that are conducive to the formulation of design equations. On the other hand, finite element analysis (FEA) leads to much more accurate magnetic field solutions because it models all flux fringing paths, but it only provides a numerical solution. In a sense, magnetic circuit analysis solves problems from a macro perspective, whereas FEA complements the design from a micro perspective. The strengths of one approach are the weaknesses of the other.

To estimate the electric loading (or the linear current density) a heat transfer model is implemented, using the maximum temperature allowed in the coils and the surrounding temperature (this study is not presented here).

To account the variation of the magnet width to pole pitch ratio, the modelling of the axial flux machine is performed in three different computation planes. The overall performance of the machine is obtained by

summing the performances of three “sub-machines”. By this way, concerning the FEA analysis, 3D FEA is avoided.

A. Magnetic circuit analysis

In each computation plane the flux densities in different parts of the machine are found based on a non-linear reluctance network over a pole pitch so that symmetry conditions are fulfilled. The reluctance network in use is presented in Fig. 4, where \mathcal{R}_y , \mathcal{R}_t , \mathcal{R}_s , \mathcal{R}_g and \mathcal{R}_m are the reluctances for the stator yoke, tooth, slot opening, air gap and permanent magnet, respectively.

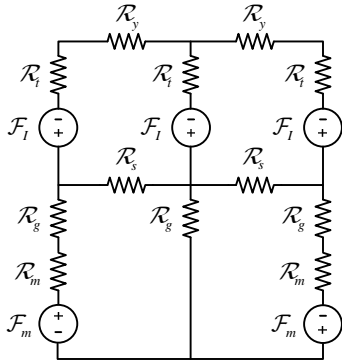

Fig. 4. Reluctance network over one pole pitch.

A particular reluctance element is calculated as

$$\mathcal{R}_i = \frac{l_i}{\mu_0 \mu_r S_i}, \quad (1)$$

where l_i is the length, μ_r is the relative permeability and S_i is the cross-sectional area of the element modelled.

The magnetomotive forces \mathcal{F}_m and \mathcal{F}_i are the MMF due to permanent magnets and stator phase currents, respectively. The MMF produced by the permanent magnet, is calculated as:

$$\mathcal{F}_m = \phi_r \mathcal{R}_m, \quad (2)$$

where $\phi_r = B_r / S_m$ is the remanent magnetic flux.

The reluctance network is solved iteratively using the matrix equation

$$\Phi = \mathcal{R}^{-1} \mathcal{F}. \quad (3)$$

The relative permeability of the iron parts (stator yoke and tooth) is a function of the flux density, being the final result of (3). For the laminated material in use, $\mu_r(B)$ is found using BH curves. Therefore, the magnetic flux vector, Φ , has to be found iteratively.

The reluctance network is solved under no-load and load conditions, with $\mathcal{F}_i = 0$ in the first case and $\mathcal{F}_i = N_s I$ in the second case, where N_s is the number of coil turns in a slot and I is the current through one coil turn.

B. 2D finite element analysis (FEA)

The no load flux density is obtained performing a magnetostatic analysis. Fig. 5 shows the magnet flux density distribution at the middle computation plane.

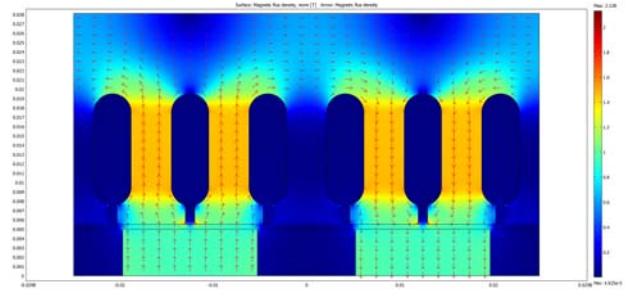

Fig. 5. Magnet flux density at the middle plane, under no load condition.

The air gap flux density over one pole is shown in Fig 6. The flux concentration effects near the tooth tips are highlighted, with an increase of the amplitude of the flux density below the tooth tip in the vicinity of the slot opening.

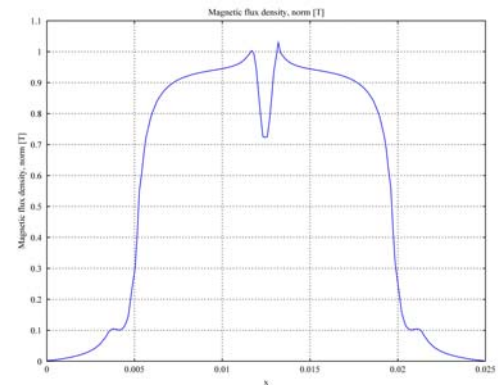

Fig. 6. Air gap flux density under no load condition.

Under load condition, in steady state operation, a magnetostatic analysis is possible, due to synchronous speed of the generator, freezing a particular instant of its operation, which corresponds to machine analysis in the rotor reference frame: for a constant synchronous speed ω_r , the operating electrical frequency is $\omega = p\omega_r$.

The surface current densities in the different slots are determined once the distribution of the winding is fixed, using the maximum value of the rated stator current and evaluating the three-phase currents for a time instant t .

For the distributed winding with one slot per pole and phase and a particular time instant with $\omega t = \pi/2$ rad, the magnet flux density distribution under rated load condition is shown in Fig. 7.

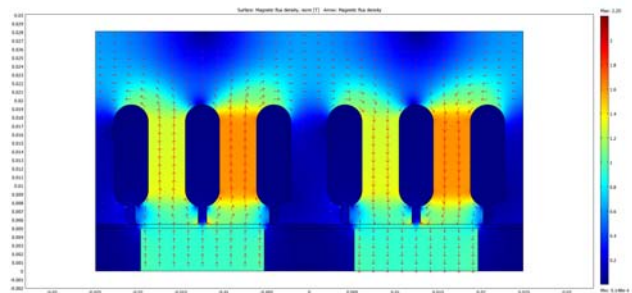

Fig. 7. Magnet flux density at the middle plane, under load condition.

4. Experimental generator

An axial flux permanent magnet low-speed generator prototype, double-sided with internal rotor and slotted stators has been constructed based on the analytical procedure whereas FEA analysis contributions have not been included. Outputs of the design study are given in Table I as well as the main parameters of the prototype.

Table I. - Main parameters of the axial flux permanent machine prototype.

PARAMETER	VALUE
Axial motor length	5,62 cm
Airgap thickness	0,5 mm
Core inner radius	6,5 cm
Core outer radius	9 cm
Permanent magnet axial length	1 cm
Magnet occupation ratio (at average radius)	0,617
Number of pole pairs	10
Pole pitch (at average radius)	2,49 cm
Permanent magnet overall weight	0,262 kg
Rated speed	600 rpm
Rated torque	5,4 Nm
Rated power (at 600 rpm)	340 W
No-load phase voltage (rms value at 600 rpm)	80,6 V
Number of phases	3
Number of coils per stator	60
Number of turns per coil	24
Number of slots per pole and phase	1
Stator phase resistance (at 20°C)	7 Ω
Linear current density (at average radius)	8,28 kA/m

The prototype machine is shown on laboratory test in Fig. 8. Stator rings are fixed to the outer frame. The three-phase windings of the two stators are connected in series and the star connection is used to avoid circulating currents. The inner rotor consists in a holed paramagnetic aluminum disk to support the NdFeB permanent magnets. Compared to the surface mounted permanent magnets in a non-holed rotor disk, this solution involves the machining and the manipulation of half magnet pieces. Axially magnetized cylindrical permanent magnets NdFeB grade N30SH are used to accomplish the excitation. Fig. 9 shows the generator rotor disk and one stator ring.



Fig. 8: Prototype generator (in laboratory).

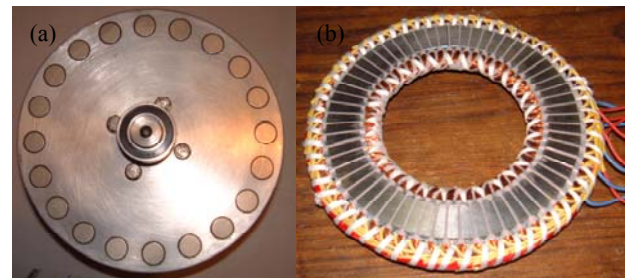

Fig. 9: Generator rotor disk (a) and one stator ring (b).

5. Test results and discussion

The machine under test has been driven by an induction generator fed by a frequency converter and loaded with a variable resistive load. The shaft torque has been measured by a torque transducer and the electrical power, current and voltage have been registered by a power analyser.

Fig. 10 shows the no load phase to neutral voltage waveform at the rated speed 600 rpm, frequency 100 Hz. This waveform has a significant 23,1% third harmonic (Fig. 11).

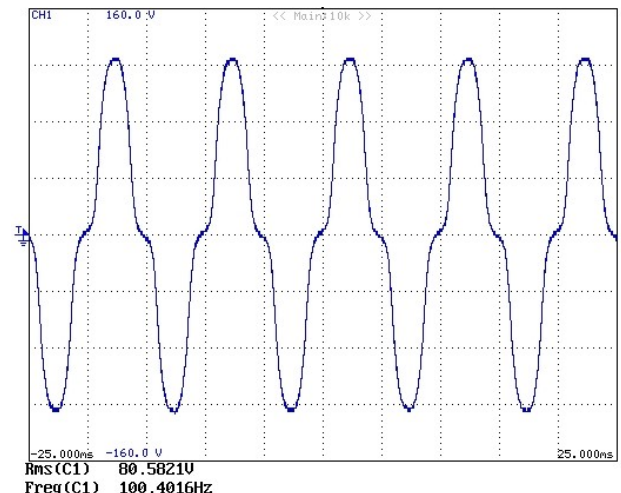

Fig. 10: No load phase to neutral voltage at 600 rpm (voltage scale: 40 V/div; time scale: 5 ms/div).

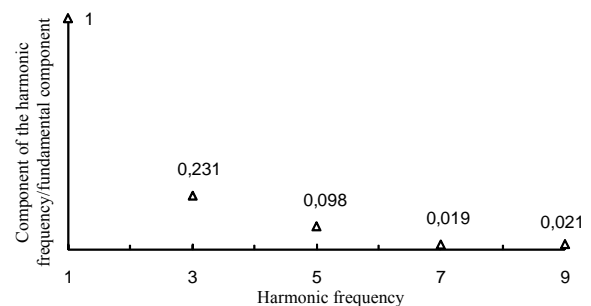

Fig. 11: Harmonic components in no load phase to neutral voltage.

The harmonic content of the no load phase to neutral voltage waveform would be substantially reduced if one stator was shifted one half of the slot pitch with respect to the other. Obviously, it should be expected a decrease of the rms value of the fundamental component as a

consequence of the electrical phase angle resulting between the EMF's induced in the two active portions of each coil of the winding. Other technical solution to achieve substantial reduction of the no load voltage harmonic content, based on magnet or slot skewing, increases the complexity of machine manufacturing.

AC resistive load tests were carried out for two different speeds from the expected operating speed range for the generator. The results are shown in Fig. 12 to 14.

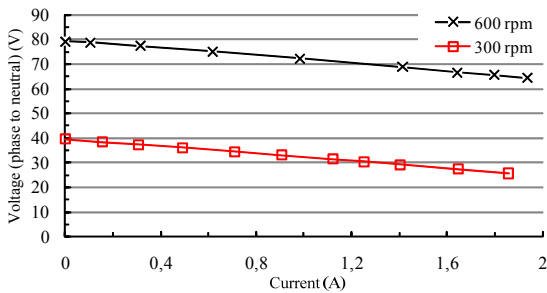

Fig. 12: Phase to neutral voltage versus current.

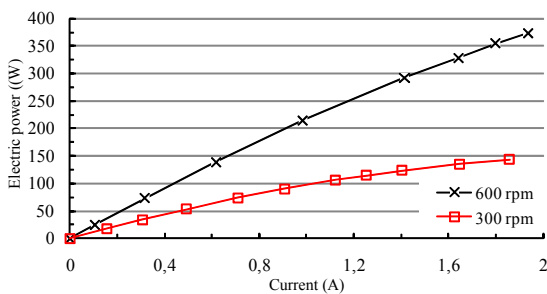

Fig. 13: Electric power versus current.

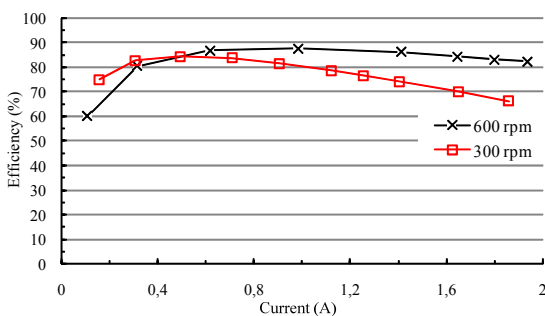

Fig. 14: Efficiency versus current.

The efficiency at rated operating condition was evaluated in 86%, which is acceptable for a non optimized prototype. The losses in the generator are dominated by stator Joule losses. Iron losses of about 6,3 W and 16,3 W were evaluated at 300 rpm and 600 rpm, respectively, while Joule losses at rated current are about 41,5 W. The higher term of Joule losses are due to large end-windings of the distributed winding arrangement used. In further investigation, it should be considered the use of concentrated windings instead of distributed windings in order to decrease the end-windings and consequently the Joule losses.

6. Conclusion

In this paper, the design and construction of an air refrigerated axial flux permanent magnet synchronous generator have been presented. Although initially designed as a direct driven generator for small-scale wind turbines, it has other application areas such as micro hydro power plants.

The generator concept was selected specifically for ease of manufacture, reliability and low cost.

An iterative design procedure has been developed using analytical and numerical approaches. The prototype has been manufactured in a preliminary stage of the development of the design procedure, thus it lacks the FEA analysis contributions.

Further investigation should be performed in order to increase the efficiency, namely the use of concentrated windings instead of distributed windings in order to decrease the end-windings and consequently the Joule losses.

References

- [1] WePower. (2010, October, 2010). *WePower, Sustainable Energy Solutions*. Available: <http://www.wepower.us/>
- [2] QuietRevolution. (2010, October, 2010). Available: <http://www.quietrevolution.com/>
- [3] HelixWind. (2010, October, 2010). Available: <http://www.helixwind.com/en/>
- [4] A. N. Celik, "Energy Output Estimation for Small-Scale Wind Power Generators Using Weibull-Representative Wind Data," *Journal of Wind Engineering and Industrial Aerodynamics*, vol. 91, pp. 693-707, 2003.
- [5] J. A. Baroudi, *et al.*, "A review of Power Converter Topologies for Wind Generators," *Renewable Energy, Elsevier*, vol. 32, pp. 2369-2385, 2007.
- [6] H. Polinder, *et al.*, "Basic Operation Principles and Electrical Conversion Systems of Wind Turbines," *EPE Journal*, vol. 15, pp. 43-50, December, 2005 2005.
- [7] T. Senjyu, *et al.*, "Wind Velocity and Rotor Position Sensorless Maximum Power Point Tracking Control for Wind Generation System," in *35th Annual IEEE Power Electronics Specialists Conference, PESC 2004*, Aachen, Germany, 2004, pp. 2023-2028.
- [8] A. P. Ferreira, "Problemática e Perspectivas da Utilização do Gerador de Ímanes Permanentes na Produção de Energia Eólica," Ms. C. Dissertation, Faculdade de Engenharia da Universidade do Porto (FEUP), Porto, Portugal, 2000.
- [9] J. R. Bumby and R. Martin, "Axial-Flux Permanent-Magnet Air-Cored Generator for Small-Scale Wind Turbines," *IEE Proceedings - Electric Power Applications*, vol. 152, pp. 1065-1075, September, 2005 2005.
- [10] M. Aydin, *et al.*, "Axial Flux Permanent Magnet Disc Machines: A Review," Wisconsin Electric Machines & Power Electronics Consortium, Madison 2004-10, 2004.
- [11] S. Huang, *et al.*, "TORUS Concept Machines: Pre-Prototyping Design Assessment for Two Major Topologies," in *IEEE Industry Applications Conference, 36th IAS Annual Meeting*, 2001, pp. 1619-1625.
- [12] A. Parviainen, *et al.*, "Axial Flux Permanent Magnet Generator with Concentrated Winding for Small Wind Power Applications," in *IEEE International Conference*

- on *Electric Machines and Drives, IEMDC'05*, 2005, pp. 1187-1191.
- [13] A. Ferreira, *et al.*, "Prototype of an Axial Flux Permanent Magnet Generator for Wind Energy Systems Applications," in *12th European Conference on Power Electronics and Applications, EPE 2007*, Aalborg, Denmark, 2007.
- [14] F. Magnussen, *et al.*, "Performance Evaluation of Permanent Magnet Synchronous Machines with Concentrated and Distributed Windings Including the Effect of Field Weakening," in *International Conference on Power Electronics, Machines and Drives (PEMD 2004)*, 2004, pp. 679-685.
- [15] A. D. Gerlando, *et al.*, "High Pole Number, PM Synchronous Motor with Concentrated Coil Windings," in *International Conference on Electrical Machines, ICEM 2004*, Cracow, Poland, 2004.
- [16] F. Magnussen and C. Sadarangani, "Winding Factors and Joule Losses of Permanent Magnet Machines with Concentrated Windings," in *IEEE International Electric Machines and Drives Conference, IEMDC'03*, Madison, Wisconsin, USA, 2003, pp. 333-339.