



2ND INTERNATIONAL WORKSHOP

ADDITIVE MANUFACTURING
AND SUSTAINABILITY

BOOK OF PROCEEDINGS

IWAM 24



OCTOBER 4TH, 2024

2nd International Workshop on Additive Manufacturing and Sustainability (IWAM 24)

Bragança - Portugal

October 4th, 2024



España – Portugal



ENERDUO



Title:

2nd. International Workshop on Additive Manufacturing and Sustainability (IWAM): book of proceedings

Editors:

João da Rocha e Silva, Instituto Politécnico de Bragança, Portugal

João Eduardo Pinto Castro Ribeiro, Instituto Politécnico de Bragança, Portugal

Jorge Santos, Instituto Politécnico de Bragança, Portugal

Rui A. Lima, Universidade do Minho, Portugal

Publisher:

Instituto Politécnico de Bragança

Campus de Santa Apolónia

5300-253 Bragança - Portugal

Publishing: 2025

ISBN: 978-972-745-346-7

Handle: <http://hdl.handle.net/10198/31129>

DOI: 10.34620/978-972-745-346-7

COMMITTEES

ORGANIZING COMMITTEE

João Rocha, Instituto Politécnico de Bragança, Portugal
João Eduardo Ribeiro, Instituto Politécnico de Bragança, Portugal
Jorge Santos, Instituto Politécnico de Bragança, Portugal
Rui A. Lima, Universidade do Minho, Portugal

INTERNATIONAL SCIENTIFIC COMMITTEE

Ana Moita, Academia Militar / IN+(IST), Portugal
Alvaro Prieto, Centro tecnológico CARTIF, Spain
Ana Fernández-Abia, University of Leon, Spain
Ana Moita, IST - Universidade de Lisboa, Portugal
Borja F. Villar, Centro tecnológico CARTIF, Spain
Delfim Soares, University of Minho, Portugal
Diana Pinho, CMEMS-UMinho, University of Minho, Portugal
Donata Putnaite, Kaunas Technikos Kolegija, Kaunas, Lithuania
Eleonora Santecchia, Università Politecnica delle Marche, Italy
Fátima Vaz, IST - Universidade de Lisboa, Portugal
Flora Silva, Instituto Politécnico de Bragança, Portugal
Helder Puga, Universidade do Minho, Portugal
Isabel Lopes, Instituto Politécnico de Bragança, Portugal
João da Rocha e Silva, Instituto Politécnico de Bragança, Portugal
João Eduardo Pinto Castro Ribeiro, Instituto Politécnico de Bragança, Portugal
Joaquin Barreiro García, University of Leon, Spain
Jolanta Pileckiene, Vilnius College of Technologies and Design, VTDK, Lithuania
José Gonçalves, Instituto Politécnico de Bragança, Portugal
Leonel Domingues Deusdado, Instituto Politécnico de Bragança, Portugal
Manuel Rodríguez-Martín, University of Salamanca, Spain
Marius Mazeika, Kaunas Technikos Kolegija, Kaunas, Lithuania
Óscar Carvalho, University of Minho, Portugal
Paula M. Barros, Instituto Politécnico de Bragança, Portugal
Renato Goulart Jasinevicius, Escola de Engenharia de São Carlos - USP, Brazil
Roberto García-Martín, University of Salamanca, Spain
Romeu Rony Cavalcante da Costa, Federal Technological University of Paraná, Brazil

Rui A. Lima, University of Minho, Portugal

Sara Giganto, University of Leon, Spain

Susana O. Catarino, University of Minho, Portugal

Susana Martínez-Pellitero, University of Leon, Spain

Teresa Guarda, Faculty of Systems and Telecommunications, UPSE, Ecuador

Viviane Teleginski, Universidade Tecnológica Federal do Paraná, Brazil

Technical Editing: Inês Afonso, Instituto Politécnico de Bragança

Technical Support: Clarisse Pais, Instituto Politécnico de Bragança

WELCOME

In recent years, the manufacturing processes have undergone a profound transformation, driven by the rapid evolution of additive manufacturing (AM) technologies. What began as a tool primarily for prototyping through stereolithography has now expanded into a versatile and innovative field capable of producing functional, end-use components across a wide range of industries. From fused deposition modeling (FDM) to selective laser melting (SLM) and beyond, AM has unlocked new possibilities in design, material utilization, and production efficiency. Today, additive manufacturing encompasses an extensive array of materials, including metals, polymers, paper, and even biological tissues, enabling applications that span from the mechanical industry to the biomedical sector.

One of the most compelling aspects of additive manufacturing is its potential to drive sustainability in modern production processes. Unlike traditional subtractive methods, which often generate significant material waste, AM builds components layer by layer, minimizing excess material and promoting resource efficiency. Furthermore, the ability to use eco-friendly and recyclable materials aligns with global efforts to reduce environmental impact. AM also supports the production of complex, customized parts on demand, reducing the need for large inventories and long-distance transportation, thereby lowering carbon emissions. By optimizing resource use and enabling more efficient production cycles, additive manufacturing is emerging as a cornerstone of sustainable manufacturing practices.

This proceeding book arrests the latest advancements, challenges, and opportunities in the field of additive manufacturing, with a particular focus on its transformative potential and contributions to sustainability. The works presented here reflect the interdisciplinary nature of AM, showcasing innovative techniques, materials, and applications that are shaping the future of manufacturing. From cutting-edge research to real-world case studies, this collection aims to inspire further exploration and collaboration, driving the adoption of additive manufacturing as a key enabler of sustainable industrial progress. We invite readers to probe into these pages and discover how AM is not only redefining manufacturing but also paving the way for a more sustainable and efficient future.

The IWAM 2024 Organizing Committee,

João Rocha

João E. Ribeiro

Jorge Santos

Rui Lima

TABLE OF CONTENTS

<i>Process Optimization of a Green Composite Containing a 3D Structure Produced via Additive Manufacturing</i>	11
<i>Artificial Intelligence for Additive Manufacturing: preliminary analysis of trends and challenges</i>	15
<i>Experimental Study of Green Nanofluids: Evaluation of Wettability, Viscosity, and Thermal Conductivity Properties</i>	19
<i>Increasing motivation and learning in digital manufacturing: Blended Intensive Programs for STUDENTS</i>	23
<i>3D Print Technologies Applied in Robotics Prototyping</i>	27
<i>Study of Electro Discharge Machining (EDM) to manufacture holes in Selective Laser Melted (SLM) parts.</i>	33
<i>Utilisation of feedstock material in additive manufacturing technology of ceramics by UV laser vat-photopolymerisation (VPP-UVL/C)</i>	37
<i>MEX and VPP-UVL Technologies for Printing Complex Alumina Parts</i>	41
<i>Design of a novel bi-phasic biomimicking auxetic 3d printed structure with fluids that biomimic the hysteretic behaviour of articular cartilage for medical phantoms</i>	45
<i>Developing optical mimicking phantoms of the head tissues – a new approach for transcranial photobiomodulation research</i>	51
<i>Optimization of PDMS Curing in SLA Resin Molds: Techniques and Approaches</i>	55
<i>Valorisation of Olive Mill Wastewaters for Industrial Applications</i>	59
<i>Effects of extensive green roofs on rainwater drainage from a metalworking industry building</i>	63
<i>Strategies for Modifying PDMS Wettability and Potential Applications</i>	74
<i>Microfabrication of a capillary-driven microfluidic device: Surface wettability</i>	78
<i>Microfabrication of a capillary flow-driven microfluidic plasma separator</i>	83
<i>Development and fabrication of a microfluidic device for mechanical characterization of malaria-infected red blood cells</i>	88
<i>3D Hollow microneedles fabrication for microfluidic applications</i>	92
<i>Linear transformations in an engineering course – Matrices and dynamic representations</i>	100
<i>Awareness of sustainability practices in construction: Learning in a real context</i>	104
<i>Acoustic stimulation based on piezoelectric materials enhanced anti-proliferative activity of triple-negative breast cancer cells</i>	108
<i>Study of the effect of the physical characteristics of bacterial nanocellulose on the proliferation of triple negative breast cancer cells</i>	112

Collaborative work between Polytechnic Higher Education students: Manufacturing processes, Safety and Sustainability..... 116

Learning linear algebra with the MathE platform: an experience in a Mechanical Engineering course 120

Enhancing Realism in 3D Mapping Through Drone-Based Photogrammetry and Animated Elements..... 124

A Review of Best Methods for 3D Scanning and Modeling of Terrain and Buildings Using Drones and Photogrammetry..... 130

Mechanical analysis of specimens generated by 3D topological optimization 135

The Role of Artificial Intelligence in Personalizing the Traveler Experience 141

Acceptance and familiarization with Wearable Devices in Portugal and Brazil..... 144

Process Optimization of a Green Composite Containing a 3D Structure Produced via Additive Manufacturing

S.M. da Costa ^{1,2,3,*}, P. Capela ⁴, M. P. André ⁴, A. S. Monteiro ⁴, M. Pereira ⁵, J.E. Ribeiro ^{3,6}, D. Soares ^{1,2}.

¹ Center for Microelectromechanical Systems (CMEMS), University of Minho, 4800-058 Guimarães, Portugal

² LBBELS – Associate Laboratory, 4710-057 Braga, Portugal;

³ Centro de Investigação de Montanha (CIMO), Instituto Politécnico de Bragança, Campus de Santa Apolónia, 5300-253 Bragança, Portugal;

⁴ Departamento de Engenharia Mecânica, Universidade do Minho, 4800-058 Guimarães, Portugal;

⁵ CF-UM-UP, Centro de Física das Universidades do Minho e Porto, 4710-057 Braga, Portugal;

⁶ Instituto Politécnico de Bragança, Campus de Santa Apolónia, 5300-253 Bragança, Portugal.

(*) **Email:** scosta@dem.uminho.pt

ABSTRACT

This study employs Dynamic Mechanical Analysis (DMA) to optimize the manufacturing process of abrasive wheels with internal three-dimensional channel structures, created by incorporating polylactic acid (PLA) through additive manufacturing, which forms specific channels during the sintering step. DMA tests were conducted to evaluate the impact of varying load and temperature cycles, aiming to minimize defects such as cracks by controlling thermal expansion and contraction, thereby preserving the integrity of the internal cooling channels. The findings suggest that removing the load, before cooling, enhances the effect of elastic recovery of the PLA structure, effectively preventing permanent deformations.

Keywords: Dynamic Mechanical Analysis (DMA); Abrasive Wheels; Polylactic Acid (PLA); Internal Cooling Channels.

INTRODUCTION

Compared with bulk wheels, textured abrasive wheels offer significant advantages in process temperature control and grinding efficiency (Chen et. al., 2023). In the studied process, additive manufacturing is used to produce the internal three-dimensional structure of channels starting from a polylactic acid (PLA) insert (Costa et. al., 2024). This structure is incorporated into the abrasive mixture during the pressing phase. During sintering, the PLA burns off, forming internal channels in the abrasive wheels. Thus, additive manufacturing enables the creation of cooling channels without significantly altering the conventional manufacturing process of the wheels.

However, the incorporation of PLA into the composite must be done carefully, as the wheel processing can be compromised by the formation of cracks during pressing and sintering. These cracks affect the efficiency and durability of the wheels. One solution to prevent these issues is by applying heat during pressing. In these circumstances, the PLA softens, allowing it to deform in a controlled manner, thus reducing internal stresses that could otherwise cause cracks (Farah et. al., 2016). Moreover, pressing with heat, facilitates the uniform compaction of the composite, minimizing stress points that lead to defect formation.

To determine the best heat and pressure combination, DMA tests were conducted simulating the pressing step of the composite with the PLA structure already incorporated. These tests evaluated the effect of two distinct load and temperature cycle combinations applied during

the processing, aiming to optimize manufacturing. The main goal was to identify the ideal conditions to ensure the structural integrity of the composite and the proper formation of the internal channels, minimizing defects such as cracks and deformations that could occur due to the plastic deformation of PLA during pressing.

METHODOLOGY

A traditional mixture of abrasive grains, matrix precursor, and binder was prepared to simulate the pressing of a structured abrasive composite in the DMA. The mixture was divided into two equal parts by mass. First, one part was placed in the crucible, followed by a PLA structure with a Y-shape, 1.0 mm thick, positioned in the centre, and then the second part of the mixture was added on top. The samples had an initial thickness of 7 mm and a diameter of 6 mm, as shown in Figure 1. Samples without the PLA structure were also produced for comparison purposes. A Dynamic Mechanical Analyzer (DMA) DMA-Q800 from TA instruments was used for these tests in compression mode. All the tests were conducted in atmospheric air, following the two Pressure/Temperature conditions shown in Figures 1b and 1c, HP1 and HP2 respectively. The thickness of the PLA structures was measured before and after the tests.

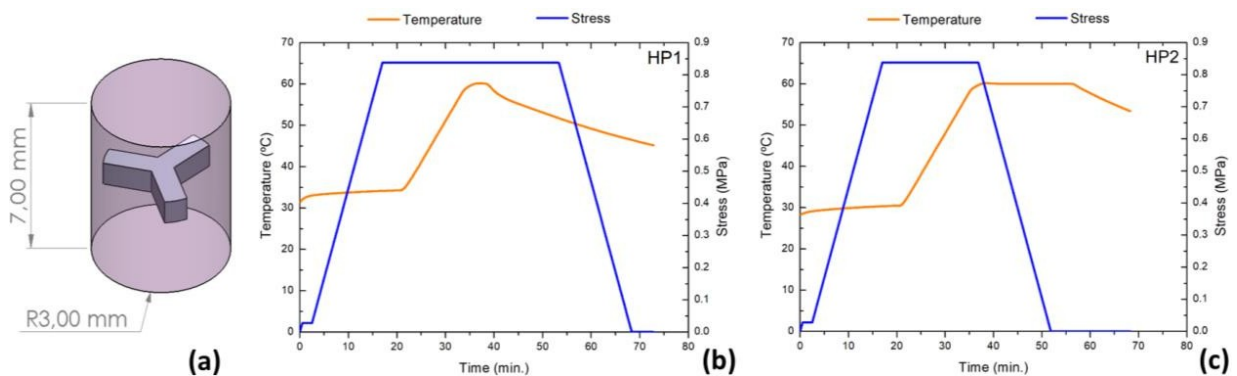

Figure 1 - Schematic representation of tested abrasive composite samples, featuring a PLA structure at the centre (a). The conditions included a maximum temperature of 60°C and an applied load of 15 N. In condition HP1 (b), after reaching 15 N, the temperature and load were applied simultaneously, whereas in condition HP2 (c), the temperature was maintained after the load was removed.

RESULTS

Two test conditions combining different load and temperature applications, HP1 and HP2 (Figures 1b and 1c), were compared during the DMA tests. Figure 2 presents the resulting deformations for each condition, showing that HP2 led to less deformation in the internal channels formed by the PLA structure.

In Figure 2, a comparison between samples HP1 and HP2 reveals that the total deformation of sample HP1 (0.92%) is more than double that of HP2 (0.44%). The deformation component associated with the composite remains similar under both testing conditions. In contrast, the deformation component related to the PLA structure significantly influences the total deformation of the sample, showing a notably higher value in HP1 (0.65%) compared to HP2

(0.23%). This difference clearly affects the outcomes of the HP1 and HP2 processes. The total dimensional recovery after removing the load is greater in HP2, at 0.43%, as the composite recovers without being restricted by the hardening of the PLA.

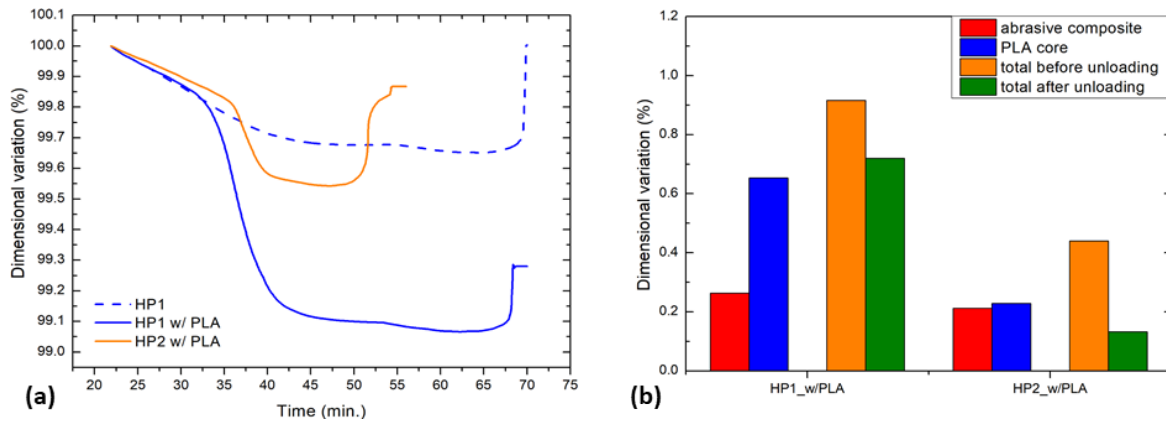

Figure 2 - (a) Dimensional variation of the abrasive composite with a PLA structure under HP1 and HP2 conditions, starting from the beginning of the thermal cycle. (b) Dimensional variations of the composite and the PLA components, as well as the total deformation of the sample, before and after unloading and recovering.

During HP1 heat and pressure combination, the PLA structure within the sample reaches its softening temperature range ($T_g = 55-60\text{ }^\circ\text{C}$) while subjected to the maximum load of 15 N. As the structure is subjected to maximum load, the temperature decreases, leading to the hardening of the polymer. As indicated by the PLA structure thickness measurement, its deformation remained after unloading, presenting a final deformation of 8%. Under these conditions, the geometry of the channels, formed by the burning of the structure during abrasive composite sintering, becomes compromised.

In contrast, with HP2, the load is removed while the composite is still at a higher temperature ($> T_g$), allowing the PLA structure to remain at a more malleable state. In these conditions, the PLA structure plastic final deformation is significantly reduced to 1% (thickness measurements results). Consequently, the internal channels may retain their designed geometry, before sintering, ensuring the structural integrity and functionality of the structured abrasive composite.

CONCLUSIONS

This study demonstrated that optimizing the heat and pressure cycles during the pressing process of abrasive wheels with three-dimensional internal PLA structures is essential for ensuring the structural integrity of the PLA structure inside, as well as its geometry. Results indicated that test conditions with load removal before temperature (HP2) minimizes plastic deformation of the channels, allowing for proper elastic recovery and preventing permanent defects. Thus, HP2 is the best condition for preserving the functionality and thermal efficiency of abrasive wheels, ensuring a more robust manufacturing process and higher quality final products.

ACKNOWLEDGMENTS

This work was supported by FCT national funds, under the national support to R&D units grant, through the reference project UIDB/04436/2020 and UIDP/04436/2020.; a PhD grant reference 2021.07352.BD, funded by FCT/MCTES (PIDDAC), granted to CIMO (UIDB/00690/2020 and UIDP/00690/2020), and SusTEC (LA/P/0007/2020).

REFERENCES

- Chen, Z., Zhang, X., Wen, D., Li, S., Wang, X., Gan, L., and Rong, X., Improved grinding performance of SiC using an innovative bionic vein-like structured grinding wheel optimized by hydrodynamics. *Journal of Manufacturing Processes*, 2023. 101: p. 195-207.
- Costa, S., Capela, P., Souza, M. S., Gomes, J. R., Carvalho, L., Pereira, M., and Soares, D., A New Grinding Wheel Design with a 3D Internal Cooling Structure System. *Journal of Manufacturing and Materials Processing*, 2024. 8(4): p. 159. <https://doi.org/10.3390/jmmp8040159>
- Costa, S., *et. Al.* Texturing Methods of Abrasive Grinding Wheels: A Systematic Review. *Materials*, 2022, 15(22), p. 8044. <https://doi.org/10.3390/ma15228044>
- Farah, S., Anderson, D. G., and Langer R., Physical and mechanical properties of PLA, and their functions in widespread applications—A comprehensive review. *Advanced Drug Delivery Reviews*, 2016. 107: p. 367-392.

Artificial Intelligence for Additive Manufacturing: preliminary analysis of trends and challenges

M. Rodríguez Martín¹, J E P C Ribeiro^{2*}, R Domingo³

¹Departament of Mechanical Engineering, Universida de Salamanca, Salamanca, Spain

¹Instituto Politécnico de Bragança, 5300-253, Bragança, Portugal

²Department of Manufacturing Engineering, UNED, Madrid, Spain

(*)**Email:** jribeiro@ipb.pt

ABSTRACT

This preliminary study examines how artificial intelligence (AI) and additive manufacturing (AM) might function together within the contexts of Industry 4.0 and 5.0, with an emphasis on how AI might improve AM procedures. Using Scopus datasets on AM and AI, a bibliometric study was carried out. The most important uses of AI in AM are tentatively and heuristically identified to draw some conclusions about future developments.

Keywords: Artificial Intelligence (AI); Additive Manufacturing (AM); Industry 4.0 and 5.0; Process Optimization.

INTRODUCTION

Companies are trying to improve flexibility and customization in their products to tailor them to the essential characteristics of customers. In this way, we can speak of custom manufacturing. In addition, AM is fully integrated into the paradigm of Industry 4.0 and 5.0, demonstrating a trend of growth and expansion to different sectors and uses. Rodríguez-Martín et al. (2024) used scientometric tools and meta-analysis to statistically demonstrate the growing relationship between AM and AI in the context of Industry 4.0 and Industry 5.0. The analysis identified clusters of research focused on applying AI to optimize AM processes, including real-time monitoring, material development, and defect detection. These findings highlight a clear trend of convergence, where AI is becoming an integral component of AM workflows. The analysis also identified four key subtopics within the broader AM research field, one of which is directly related to the integration of AI and Industry 4.0 technologies. These results emphasize the crucial role of AI in shaping the future of AM, as AI-powered tools are increasingly being adopted at every stage of the AM process.

The integration of AM and AI is driving a new era of industrial and technological innovation. AM facilitates the creation of complex geometries and customized products without requiring large-scale equipment typically found in factories. AI enhances this process by improving designs, optimizing AM parameters, and ensuring quality control. A quantitative analysis based on bibliometric data, as well as a qualitative review of recent scientific literature, will be conducted to outline the main research trends that synergize AM and AI from some consolidated works.

A quantitative analysis based on bibliometric data will be performed. Parallely, a non-exhaustive qualitative analysis based on recent scientific literature will be addressed to draw the main research lines in synergy between AM and IA.

BIBLIOMETRIC ANALYSIS

A single bibliometric analysis has been performed using two datasets from Scopus: one containing academic works on AI (531,546 works) and another on AM (73,932 works). Both topics show a clear upward trend in publication volume in recent years (Fig. 1). However, while AI has been developing for a longer time, the rise in AM publications is more recent. As a result, no strong correlation exists between the annual publication variations for these topics (Fig. 2). This implies that the the development of both technologies has been growing in recent years, but they have not progressed at the same pace.

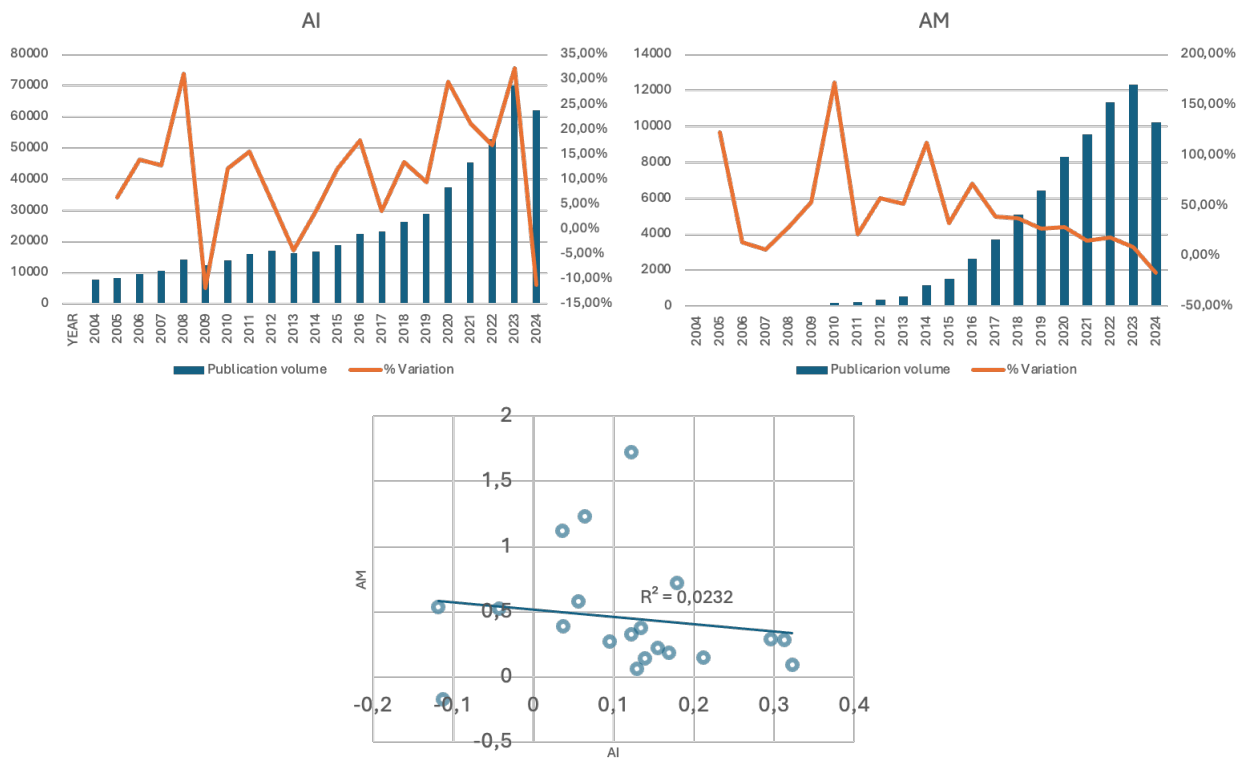

Figure 1 - Left: evolution of the number of papers on AI (up) and AM (down). Search criteria for AI “Artificial intelligence” and “Additive Manufacturing”. In the two cases for “Article title, abstract, and Keywords”. Right: correlation between the % variation of each topic.

AI for DfAM

Design-oriented to Additive Manufacturing (AM), often referred to as Design for Additive Manufacturing (DfAM), involves tailoring product design to leverage the specific capabilities of AM processes (different from other manufacturing processes). Aspects such as topology optimization, customization and flexibility, minimization of waste, and complex geometries take part in the DfAM. Making the design process benefit from possible multivariate statistical analyses that can be difficult to process with traditional statistical methods and that, in turn, require learning for continuous improvement. In this way, IA, specifically Machine Learning (ML), has advanced from predicting material properties to designing novel metamaterials, and additive manufacturing (AM) techniques can now fabricate complex designs that were previously unachievable.

Recent advancements include fully automated ML processes that generate optimal structures for metamaterials (e.g. Deng et al., 2023; Chen et al. 2018) that could be used for AM. Convolutional neural networks (CNNs) are used to analyze randomly generated microstructures, discovering new patterns that are significantly stronger and tougher.

AI for parameters optimization in AM

Different additive processes have unique operational characteristics, specific materials, and distinct workflows, often requiring additional steps beyond just 3D printing. In addition, the configuration of the process itself can benefit from statistical analysis using AI tools and some works have implemented a systematic review of this issue (González-Peña, 2023). Machine Learning methods, both classification and regression, provide the ability to optimize these characteristics (e.g. Silbernagel., 2020) even with an objective of energy savings in additive processes (Alazideh., 2020).

AI to enhance quality control and evaluation

Since real-time control is an important variable to predict the quality of additive processes, different variables can be extracted in real-time from the processes. ML algorithms allow the processing of these variables to provide predictive results of the final product quality. In addition, AI can be integrated to improve defect detection processes in non-destructive testing (e.g. Rodríguez-Martín et al., 2022).

CHALLENGES AND FUTURE GOALS

The effective use of AI in AM depends largely on the availability of high-quality data, with the demand for data increasing as complexity grows. The capability to process data in real-time also depends on the computational capacity of the resources available to work with large volumes of data. It is expected that as AI becomes more democratized at the development level, and as progress is made in improving the graphic and processing capacity, new uses and potential of AI will be discovered to favor additive processes both in the conceptualization and design phase-oriented towards AM, as well as in the quality control phase of the process. Finally, future work could address a holistic review that confirms or disconfirms the results shown in this preliminary, limited, and non-exhaustive study.

ACKNOWLEDGMENTS

This work has been carried out for the NaturFAB research project (0049_NATUR_FAB_2_E) “Fomento de la especialización inteligente, transición industrial y emprendimiento a través de nuevos materiales” founding in the Interreg-POCTEP (European Commission).

REFERENCES

- Alizadeh M., Esfahani M. N., Tian W., and Ma J. Data-Driven Energy Efficiency and Part Geometric Accuracy Modeling and Optimization of Green Fused Filament Fabrication Processes. *ASME. J. Mech. Des.*, 2020, 142(4): p. 041701. <https://doi.org/10.1115/1.4044596>
- Chen D., Skouras B. Z., Su I., and Matusik W. Computational discovery of extremal microstructure families. *Science Advances*, 2018, 4(10). <https://doi.org/10.1126/sciadv.aao7005>
- Deng B., Kim S., and Matusik W. Computational discovery of microstructured composites with optimal stiffness-toughness trade-offs. *Science Advances*, 2023, 9(35), adk4284. <https://doi.org/10.1126/sciadv.adk4284>
- González-Peña M., Amigo A., Gómez E. Optimization with artificial intelligence in additive manufacturing: a systematic review. *Journal of the Brazilian Society of Mechanical Sciences and Engineering*, 2023
- Ribeiro J., Rodríguez-Martín M., Barreiro, J., Fernández-Abia, A., García-Martín, R., Rocha, J., Martínez-Pellitero, S. New trends of additive manufacturing using materials based-on natural fibers and minerals: A systematic review. *Heliyon*, 2025, 11(2), e41993. DOI: <https://doi.org/10.1016/j.heliyon.2025.e41993>
- Rodríguez-Martín M., Domingo R., and Ribeiro J. Mapping and prospective of additive manufacturing in the context of Industry 4.0 and 5.0. *Rapid Prototyping Journal*, 2024, 30(7): p. 1393-1410. <https://doi.org/10.1108/RPJ-11-2023-0410>
- Rodríguez-Martín M., Fueyo J.G., Pisonero J., López-Rebollo J., Gonzalez-Aguilera D., García-Martín R., and Madruga F. Step heating thermography supported by machine learning and simulation for internal defect size measurement in additive manufacturing. *Measurement*, 2022, 205: p. 112140. <https://doi.org/10.1016/j.measurement.2022.112140>
- Silbernagel C., Aremu A., and Ashcroft I. Using machine learning to aid in the parameter optimisation process for metal-based additive manufacturing. *Rapid Prototyping Journal*, 2020, 26(4): p. 625–637. <https://doi.org/10.1108/RPJ-11-2019-0295>
- Yao X., Moon S. K., and Bi G. A hybrid machine learning approach for additive manufacturing design feature recommendation. *Rapid Prototyping Journal*, 2017, 23(6): p. 983-997. <https://doi.org/10.1108/RPJ-09-2016-0159>

Experimental Study of Green Nanofluids: Evaluation of Wettability, Viscosity, and Thermal Conductivity Properties

G Nobrega^{1,2,*}, B Cardoso¹, D Pinho³, J E P C Ribeiro², R A Lima¹

¹ Mechanical Engineering and Resource Sustainability Center (MEtRICs), Mechanical Engineering Department, University of Minho, Campus de Azurém, 4800-058, Guimarães, Portugal

² Centro de Investigação de Montanha (CIMO), Instituto Politécnico de Bragança, Campus de Santa Apolónia, 5300-253, Bragança, Portugal

³ Microelectromechanical Systems Research Unit (CMEMS-UMinho), School of Engineering, University of Minho, Guimarães, Portugal; LBBELS—Associate Laboratory, Braga/Guimarães, Portugal

(***Email:** glaucotvn@hotmail.com)

ABSTRACT

Nanoparticles have gained significant attention for their diverse applications in fields such as medicine, electronics, and heat transfer due to their unique thermal, optical, and magnetic properties. However, conventional synthesis methods often involve toxic chemicals and high energy consumption. In this study, we report the green synthesis of magnetic iron oxide nanoparticles (Fe_3O_4 NPs) using *Chlorella vulgaris* extract as a bioreducing and stabilizing agent, offering an environmentally friendly alternative to conventional methods. The synthesized Fe_3O_4 NPs were incorporated into nanofluids using water as the base fluid with different NPs concentrations (0.01wt%, 0.05wt%, and 1wt%) to assess their performance in thermal systems. The thermophysical properties of all nanofluids, including wettability, viscosity, and thermal conductivity, were thoroughly investigated. The cumulative addition of Fe_3O_4 NPs to water significantly enhanced the corresponding wettability by reducing the contact angle on different substrates. At the same time, viscosity showed only a minor increase with higher NPs concentration on nanofluids. Notably, thermal conductivity improved by up to 11% at higher Fe_3O_4 NPs concentrations (1wt%), indicating the potential of these green-synthesized nanofluids for heat transfer applications in single-phase and two-phase systems. This study highlights the benefits of green synthesis methods and the applicability of these nanofluids in industrial thermal management.

Keywords: Green Synthesis; Magnetic Iron Oxide Nanoparticles; Nanofluids; Thermal Conductivity.

INTRODUCTION

The diversity of metallic nanoparticles (MNPs), including their thermal, magnetic, plasmonic, optical, and catalytic capabilities, is one of their greatest advantages (Kelly et al., 2003 and Khan et al., 2022). It is possible to create magnetic nanoparticles via physical, chemical, and biological techniques (Iravani et al. 2014). In recent years, the scientific community has focused on green synthesis techniques (Mustapha et al., 2022). These techniques employ a variety of natural resources as stabilizers and reducing agents in the manufacture of metallic nanoparticles (Gour & Jain, 2019; Afonso et al., 2024).

This study describes a green synthesis of magnetic iron oxide nanoparticles utilizing an algae extract from *Chlorella vulgaris*. Wettability, viscosity, and thermal conductivity are all assessed

as part of the study of the thermal performance of NFs containing these green nanoparticles.

RESULTS

According to the wettability tests, the fluid became more hydrophilic, and the contact angle decreased when green-produced magnetic nanofluid was added. Apart from the sample on aluminium, an instantaneous decrease in the contact angle was noted even at the lowest concentrations, as illustrated in Figure 1.

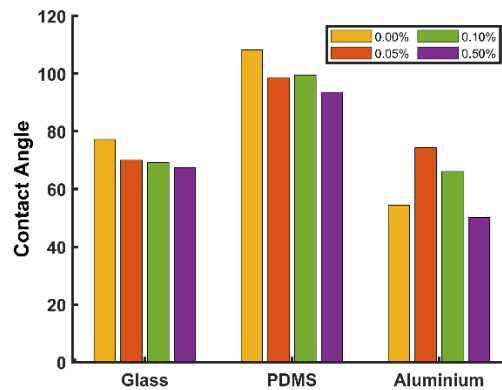

Figure 1 - Contact angle for GMNF at various concentrations on glass, PDMS, and aluminium substrate.

Figure 2 shows the viscosity data as a function of shear rate. The findings are displayed for every tested concentration in addition to the base fluid (water). There is a modest increase in fluid viscosity when compared to water. Regarding the correlation between viscosity and the concentration of nanoparticles, a slight rise was noted, with this link being more noticeable between concentrations of 0.05 and 0.1%.

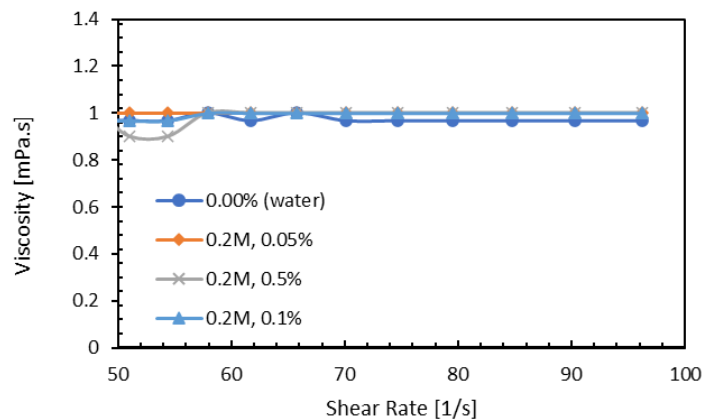

Figure 2 - For GMNF, viscosity as a function of shear rate.

Depending on the amount, adding NPs to water affects thermal conductivity in different ways. Figure 3 shows that small amounts were found to reduce heat conductivity. At a concentration of 0.10%, however, thermal conductivity started to grow as NP concentration increased, eventually surpassing that of pure water. This pattern persisted, with greater doses showing a noteworthy 11.3% increase in thermal conductivity.

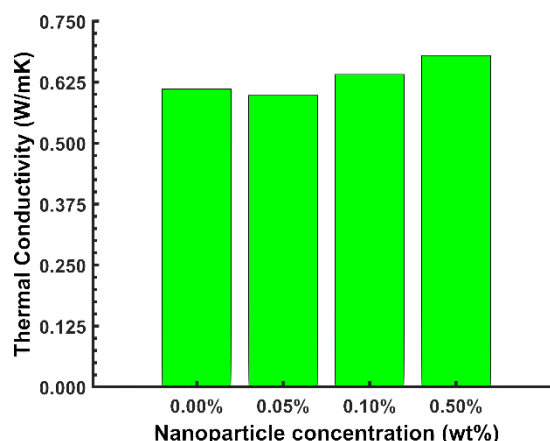

Figure 3 - Variation in the nanofluid's thermal conductivity as a function of the percentage of nanoparticles.

CONCLUSIONS

The findings showed that while using GMNPs may make the base fluid less desirable at low concentrations, increasing the concentration produced favourable outcomes or did not impair the fluid's qualities in any of the tests that were carried out. This shows that heat transfer applications in single- and two-phase systems have a lot of potential.

ACKNOWLEDGMENTS

This work was supported by the projects, 2022.02085.PTDC(<https://doi.org/10.54499/2022.02085.PTDC>) and 2022.06207.PTDC (<https://doi.org/10.54499/2022.06207.PTDC>), through national funds (OE), within the scope of the Scientific Research and Technological Development Projects (IC&DT) program in all scientific domains (PTDC), through the FCT, I.P. The authors also acknowledge the partial financial support within the R&D Units Project Scope UIDB/04436/2020, UIDP/04436/2020, UIDB/04077/2020, UIDP/04077/2020, UIDB/00532/2020, UIDB/00690/2020 and LA/P/0045/2020 (ALiCE). Diana Pinho thanks to FCT for the individual funding 2021.00027.CEECIND/CP1664/CT0007, (<https://doi.org/10.54499/2021.00027.CEECIND/CP1664/CT0007>). The authors are also grateful for FCT funding through Project PTDC/EMETED/ 7801/2020 and UIPD/50009/2020-FCT and UIDB/50009 – FCT. A.S. Moita and Reinaldo Souza also acknowledge FCT for partially financing their contracts through CEECINST/00043/2021/CP2797/CT0005, doi: 10.54499/CEECINST/00043/2021/CP2797/CT0005 and 2022.03151.PTD (<https://doi.org/10.54499/2022.03151.PTDC>) and LA/P/0083/2020 IN +-IST-ID. The authors are grateful to Professor Margarida Gonçalves and Professor Andrea Zille for providing materials and equipment, as well as for their technical support. Nobrega was supported by the doctoral PRT/BD/153088/2021, financed by the Portuguese Foundation for Science and Technology (FCT), and with funds from MCTES/República Portuguesa, under MIT Portugal Program. and for financial support through national funds FCT/MCTES (PIDDAC) to CIMO (UIDB/00690/2020 and UIDP/00690/2020) and SusTEC (LA/P/0007/2020).

REFERENCES

- Afonso I, Cardoso B, Nobrega G, Minas G, Ribeiro J, Lima R. Green synthesis of nanoparticles from olive oil waste for environmental and health applications: A review. *Journal of Environmental Chemical Engineering*, 2024; 12(5), 114022. DOI: 10.1016/j.jece.2024.114022
- Gour A, Jain NK. Advances in green synthesis of nanoparticles. *Artificial cells, nanomedicine, and biotechnology*. 2019;47(1):844-51.
- Iravani S, Korbekandi H, Mirmohammadi SV, Zolfaghari B. Synthesis of silver nanoparticles: chemical, physical and biological methods. *Research in pharmaceutical sciences*. 2014; 9(6):385.
- Kelly KL, Coronado E, Zhao LL, Schatz GC. The optical properties of metal nanoparticles: the influence of size, shape, and dielectric environment. *ACS Publications*; 2003. p. 668-77.
- Khan S, Hossain MK. Classification and properties of nanoparticles. *Nanoparticle-based polymer composites*: Elsevier; 2022. p. 15-54.
- Mustapha T, Misni N, Ithnin NR, Daskum AM, Unyah NZ. A review on plants and microorganisms mediated synthesis of silver nanoparticles, role of plants metabolites and applications. *International Journal of Environmental Research and Public Health*. 2022;19(2):674.

Increasing motivation and learning in digital manufacturing: Blended Intensive Programs for STUDENTS

João Rocha^{1,3*}, Leonel Deusdado¹, Jorge Santos¹, Catarina Rocha¹, Isabel Lopes^{1,4}, João Ribeiro^{1,2}

¹Instituto Politécnico de Bragança, 5300-253, Bragança, Portugal

²Mountain Research Center (CIMO), Polytechnic Institute of Bragança, 5300-252 Bragança, Portugal

³Sustainable Construction Research Group (GICoS), Polytechnic Institute of Bragança, 5300-252 Bragança, Portugal

⁴Applied Management Research Unit (UNIAG), Polytechnic Institute of Bragança, 5300-252 Bragança, Portugal

(*)**Email:** jrocha@ipb.pt

ABSTRACT

This article explores an innovative approach to teaching digital manufacturing, with a particular focus on additive manufacturing, through a structured set of tasks involving 3D scanning and printing. The pedagogical project stands out for its unique integration of international students from multiple institutions and diverse academic backgrounds, made possible through the Blended Intensive Program (BIP). This program brought together students from various disciplines within Science, Technology, Engineering, Arts, and Mathematics (STEAM), fostering an interdisciplinary learning environment.

By engaging students in hands-on activities that combine theoretical knowledge with practical implementation, the program encourages active participation and collaborative problem-solving. Participants worked in multicultural teams, sharing expertise and experiences to overcome technical challenges related to digitalization and additive manufacturing. Research findings indicate that this approach yields excellent results in terms of student engagement, motivation, and learning outcomes. The structured yet flexible nature of the program allows students to develop both technical and creative skills while working in a dynamic, competitive environment.

Furthermore, the BIP framework enhances students' ability to adapt to real-world scenarios, where teamwork and interdisciplinary collaboration are essential. By integrating practical experience with theoretical instruction, this approach strengthens their problem-solving abilities and prepares them for future professional challenges in the rapidly evolving field of digital manufacturing.

Keywords: Digital Manufacturing; Additive Manufacturing; Blended Intensive Program (BIP); Student Engagement.

INTRODUCTION

The Blended Intensive Program (Commission, 2024) in Digital Manufacturing was organized by the Instituto Politécnico de Bragança with virtual classes between October 23 and December 15, 2023 with the in-person week from January 15 to 19, 2024. The program had a total of 26 registered foreign students: 1 from Hradec Kralove University, 1 from Business and Technology University, 5 from Kaunas University of Applied Engineering Sciences, 2 from Vilnius Gediminas Technical University, 1 from Vilnius College of Technology and Design, 7 University of Applied

Sciences in Konin, 3 from the Nowy Sacz University of Applied Sciences, 3 from the Opole University of Technology, 3 from the Nova University of Applied Sciences. 20 students successfully completed ERASMUS mobility, one of which did not come from a European Union university .

During the face-to-face week, students had the opportunity to put into practice the skills acquired during online learning, ending with the presentation of a solution to a specific problem.

The social part of the program was very important to create a strong group where mutual help was always present. In this multicultural context, the feeling of belonging to the European Union was reinforced (Hamonc, et Al., 2023, IPPortalegre, (n.d.), IPVC, (n.d.), Zabala et Al., 2024).

BIP STRUCTURE

During the period allocated to the online part, several teachers were responsible for one of the planned areas of the program. Groups of students were created, incorporating elements from different countries and cultures, ensuring a rich multicultural experience. This approach encouraged collaboration and exchange of ideas among participants with diverse backgrounds. Support materials, including recorded lectures, tutorial videos, and supplementary readings, were made available by teachers for students who were unable to attend an online class. Additionally, discussion forums and Q&A sessions were organized to help clarify doubts and reinforce learning.

For the students, the face-to-face BIP included the participation of five teachers, who addressed the topics foreseen in the program. These topics encompassed a detailed study of a digitalization case, point cloud treatment, segmentation, and the 3D printing of a building (a small church in the city). Other activities included the design and production of a tactile plant adapted for the blind, using laser cutting and engraving, as well as the design and production of the wooden course logo. Additionally, students explored virtual reality applications developed through digitalization, providing an immersive perspective on their projects.

Student assessment was carried out by all teachers, taking into account the results of the challenges (50% weight) and a presentation made by each of the groups (50% weight). Given the highly practical nature of the course, adapted to each student's previous training and experience, the results were very positive and were shared among all participants. The dynamic environment fostered creativity, teamwork, and hands-on learning.

The face-to-face component consisted of 26.5 hours of preparatory work, which included scanning, modeling, processing, printing, cutting, and laser engraving. Throughout this phase, students worked in multidisciplinary teams, ensuring an interdisciplinary approach to problem-solving. In the final stage, they had 3.5 hours to present their work in groups in an interactive session where they showcased their final projects. This session allowed students to explain their methodologies, discuss challenges faced, and reflect on the knowledge gained throughout the course.

CHALLENGES

The students were challenged to try the software and equipment to understand using the Do it Yourself (DIY) method, taking advantage of the knowledge of students coming from various areas of knowledge (STEAM) (Manikutty et al., 2022).

The groups, previously formed, after the initial challenge, began their work obtaining the point cloud of a building in the city, using the equipment available in the laboratory, FARO Focus Scanners.

Participants were then challenged to work on this point cloud until they obtained a 3D model of the building. Depending on the experience and scientific area of origin of the members of each group, they obtained slightly different models, giving more emphasis to some details and less to others.

Finally, models were created, using different equipment and different materials.

In the time still available after completing the models, tactile plans were created for the blind. In addition to consolidating technical knowledge, participants in this program felt the need to work towards the inclusion of all European citizens in all societal activities. In addition to the scheduled hours, some students requested access to the FabLab IPB laboratory, in order to carry out extra work.

As part of the social program, all participants were invited to take part in a friendly dinner, held in the university restaurant. A visit was made to the city's museums (Iberian Museum of Mask and Costume, Georges Dussaud Photography Center, Graça Morais Museum of Modern Art, Municipal Theater of Bragança and Railway Museum Núcleo Museológico de Bragança, Figure 1) where there are models and tactile plants intended to the inclusion of blind people, and where they observed a practical application of their work (scanning, printing, cutting and engraving).



Figure 4 steam engine on display at the Railway Museum digitized and printed by the FabLab team

There was also time for the tourist component with a visit to the city of Bragança, the typical village of Rio de Onor and the Castro de Avelãs Monastery, both in the municipality of Bragança, important tourist attractions.

RESULTS

Regarding student feedback, they were asked to answer the question, “What did you do?” and “What would you like to have been more developed?”

Some highlights of what they learned: “SketchUP Pro” and other software, “Laser cutting”, “Point

Cloud and 3D models”, “What to think about when you want to make, for example, maps for the blind”, that is, thinking in different way for inclusion and very important “Local and International Culture”, that is, increasing awareness that they are European Citizens!

Some of the “requests” do not depend on the BIP organization, such as “better climate” and “more face-to-face days” or “more trips”, but others will be considered in a future edition such as “More VR”, “More individual creation”.

For the second edition of this BIP program, applications were received from several universities in the European Union and also from outside the Union

Due to the answers given to these questions and the adherence to the second edition of this BIP, due to its geographic and scientific origins, the organization is convinced that this method resulted in the acquisition of skills in digital manufacturing.

REFERENCES

Badiola Zabala, A., Alves Lopes, A., Casaca Carreira, J., Costa, D., Brottrager, B., Wittkämper, D., Molenaar, E., Maric, F., Kjønnørød, I.-C., Wijchen, J. van, & Jokinen, K. (2024). Blended Intensive Programs in Higher Education: Collaborative Innovation for Global Health Challenges. Repositório Comum. Retrieved from <http://hdl.handle.net/10400.26/52131>

Commission, E. (2024). Blended intensive programmes. Retrieved from <https://wikis.ec.europa.eu/display/NAITDOC/Blended+Intensive+Programmes>

Hamonic, E., Hopma, A., Gaultier, B., & Moalic, D. (2023). Teaching digital manufacturing: Experimenting blended-learning models by combining MOOCs and on-site workshops in FabLabs. arXiv preprint arXiv:2303.04019. Retrieved from <https://arxiv.org/abs/2303.04019>

Instituto Politécnico de Portalegre (IPPortalegre). (n.d.). Blended Intensive Program on Digital Transformation. Retrieved from <https://bip.ipportalegre.pt/>

Instituto Politécnico de Viana do Castelo (IPVC). (n.d.). Blended Intensive Programme (BIP). Retrieved from <https://www.ipvc.pt/internacional/mobilidade-programas/erasmus/blended-intensive-programme-bip/>

Manikutty, G., Sasidharan, S., & Rao, B. (2022). Driving innovation through project-based learning: A pre-university STEAM for Social Good initiative. <https://doi.org/10.1109/FIE56618.2022.9962420>

3D Print Technologies Applied in Robotics Prototyping

Mariano Alvarez¹, Laiany Brancalião¹, João Coelho¹, Jorge Carneiro², Paulo Costa³, Miguel Conde⁴ and José Gonçalves¹

¹Research Centre in Digitalization and Intelligent Robotics (CeDRI), Instituto Politécnico de Bragança, Campus de Santa Apolónia, 5300-253 Bragança, Portugal

²GRETEL – Produtos Cerâmicos, S.A. Vagos, Portugal

³Faculty of Engineering of the University of Porto, 4200-465 Porto, Portugal

⁴University of León, Campus de Vegazana, 24071 León, Spain

(*)**Email:** marianoalvarez@ipb.pt

ABSTRACT

This paper explores the use of 3D printing technology in industrial and educational environments, for robotics applications, emphasizing its versatility, cost-effectiveness, and rapid prototyping capabilities. Several projects are discussed, including the STC 4.0 HP Project, which combines 3D printing with robotic automation in the ceramics industry and creating educational robots for hands-on learning. 3D printing enables rapid iterations in these projects, allowing continuous improvements and adaptations. This technology's potential is further demonstrated by its application in creating custom accessories, such as sensor adapters, which can be reused and modified across multiple projects. The findings demonstrate how 3D printing promotes innovation and accessibility, particularly in robotics, making it an important tool in industry and education.

Keywords: 3D Printing Technology; Robotics Applications; Rapid Prototyping; Industrial and Educational Innovation.

INTRODUCTION

The growing popularity of 3D printing is not new. People worldwide can now utilize this technology, and its advantages are growing. Numerous examples of 3D printing applications may be found in industry and education.

The flexibility that robotics enables in prototyping is one of the main benefits of developing systems for the industrial sector. It offers more flexibility, faster lead times, and lower costs than other technologies. Models of parts and structures were 3D printed in PLA in [1, 2, 3], allowing for testing different strategies without producing a set structure that would be difficult to adapt when new needs emerged. The accessibility of additive manufacturing is a significant advantage as well.

Anyone who desires a model can get one. Several robot designs were developed in [4, 5] to enhance learning in the classroom. Students could print copies of these models and make any desired changes after making them available as open-access files.

3D PRINTING APPLICATIONS

STC 4.0 HP Project

In the STC 4.0 HP Project, in cooperation with the ceramic industry company Grestel, the primary

objective was to develop and implement an automated system for finishing ceramic pieces after they were removed from their molds. A robotic manipulator was used to lift and handle the pieces. Additionally, a structure was designed to support a sponge powered by a motor.

The structure supporting the sponge was designed in SolidWorks as a box in which the sponge rotates, driven by a DC motor (Figure 1a). This first version was modified to create a second version, replacing the DC motor with an AC motor, allowing for better control over the sponge's rotation (Figure 1b).

3D-printed plate-shaped pieces were used to calibrate and test the system's functionality. These pieces were attached to the manipulator as substitutes for the actual ceramic pieces, which were much more fragile (Figure 1c).

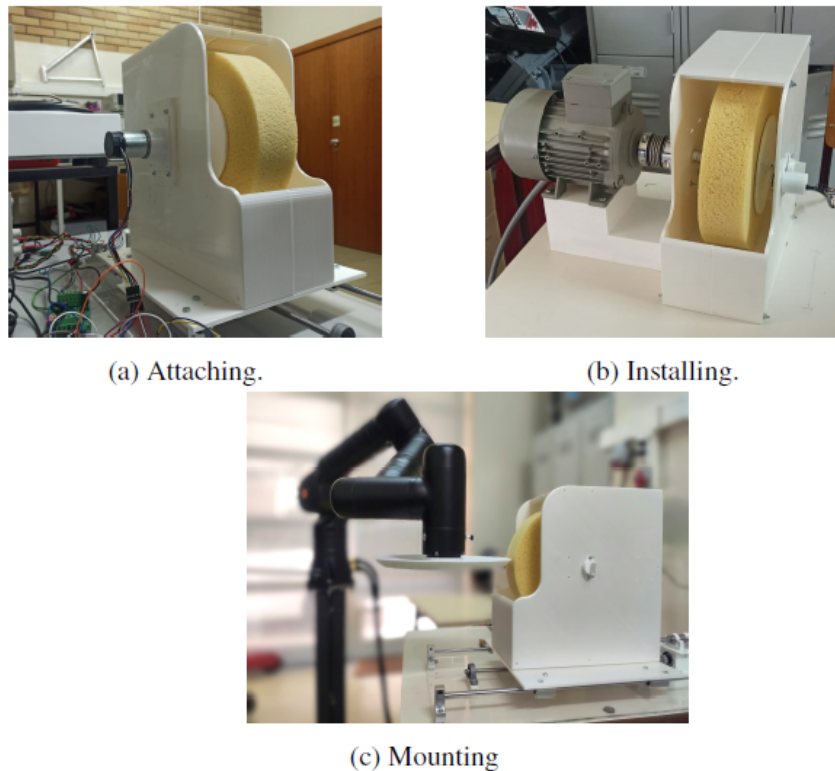

Figure 1 - Step-by-step assembly stages of the manipulator robot.

MOBILE ROBOTICS

Another project that used additive manufacturing technology involved the application of robotics as a teaching tool. In one instance, four line-following robots were 3D printed and assembled (Figure 2a), then distributed to different groups of students from the Master's degree programs in Electrical and Mechanical Engineering at the Polytechnic Institute of Bragança [4, 6].

The robot prototype has differential kinematics and was designed to be able to follow a line and avoid obstacles. The mechanical design, presented in Figure 2b, was 3D-printed and included two wheels, a chassis to load the electronic components, and two additional parts for attaching sensors.

The hardware module consists of an Arduino Mega microcontroller responsible for data

processing, two DC motors with built-in encoders for robot locomotion allowing a closed-loop speed control and odometry estimation, a FIT0450 drive board to control these motors, a QTR-8A line sensor that detects the line the robot should follow, a VL53L0X Time Of Flight (TOF) distance sensor that provides data for obstacle avoidance and two rechargeable 3.7V Lithium Ion batteries for system power. To prevent battery damage, the robot also features an auto-power-off function. All files related to the mobile robots were made available to students of the robotics course. The files related to the mobile Robot prototypes are available online through the link: <https://github.com/Laiany/Educational-Mobile-Robots-Prototype.git>.

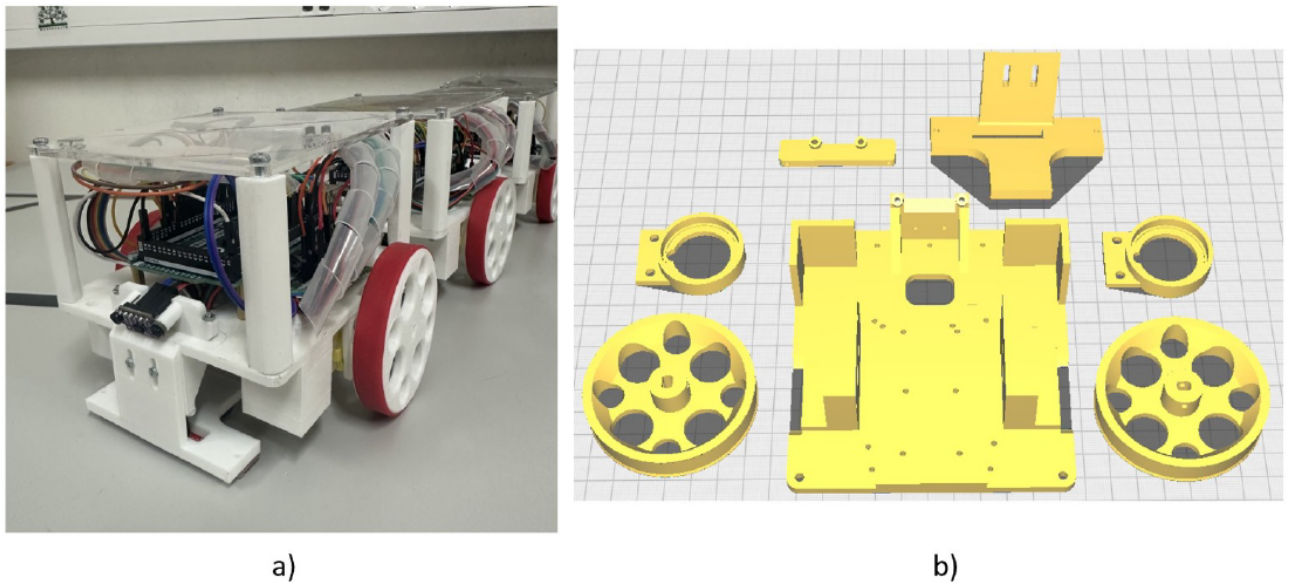

Figure 2 - a) Assembled mobile robots. b) Mechanical design.

Manipulator Robot Prototype

Another project involving a manipulator robot, in which the authors of this article actively participated [5], demonstrates the use of 3D printing in robotics. The project centered around the prototyping and control of a 3 degrees of freedom (DOF) manipulator robot explicitly designed for educational purposes in classroom settings. The design and construction of this robot proved to be a straightforward task, promoting quick iterations for improvements and enabling refinements. This iterative process enhanced the robot's functionality and made it feasible to implement real-time modifications, ultimately leading to an optimized prototype for educational use. Figure 3 visually captures the step-by-step assembly stages of the final robot.

In Figure 3, the 3D-printed robot parts allowed for a rapid assembly process, enabling quick identification and correction of design flaws. Reprinting and replacing individual parts made it easy to iterate on the design, allowing the cycle of testing, refining, and reprinting to continue efficiently until the final result met the desired specifications. This process made replicating and improving the manipulators both simple and cost-effective.

Accessories

Another advantage of using 3D printing can be seen in its application for creating accessories for various projects. One example is the creation of an adapter for a TOF (Figure 4a), which was mounted and manipulated by a collaborative robot [7, 8]. The same adapter was modified and reused on two more occasions: once to integrate a LiDAR sensor (Figure 4b) and another to mount a laser engraver (Figure 4c) [9].



(a) Attaching the servo motor to the base support, enabling rotation. (b) Installing the main gear interacting with the base to spheres, drive rotation. (c) Adding the lower gear, and pulley to enable smooth base rotation.

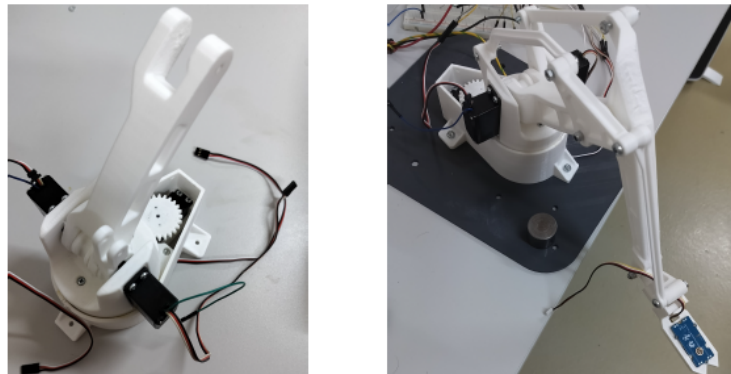

(d) Mounting the shoulder and elbow servo motors, along with the elbow arm and gripper. (e) Final assembly, completing the shoulder arm.

Figure 3 - Step-by-step assembly stages of the manipulator robot.

CONCLUSION

These are just a few examples of the versatility that 3D printing provides for robotics. This demonstrates how additive manufacturing can simplify complex tasks, speed up iteration cycles, and produce custom components. This adaptability is especially useful in educational environments where students can actively participate in design and prototyping, gaining a better understanding of robotics and engineering concepts. Furthermore, the ability of 3D-printed parts to be reused via accessories such as sensor adapters demonstrates how this technology promotes resourcefulness and innovation. As 3D printing evolves, its role in facilitating the development of functional prototypes and increasing robotics accessibility will grow, cementing its importance in industry and robotics education.

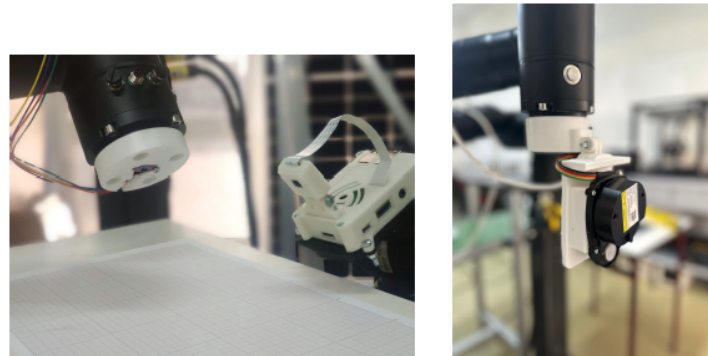

(a) Adapter for TOF.

(b) Adapter of LiDAR.

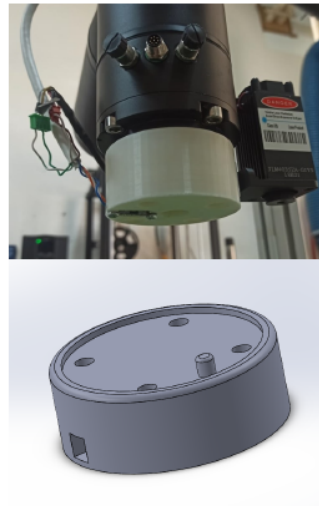

(c) Attachment for laser engraver.

Figure 4 - Accessories printed for a robotic manipulator.

ACKNOWLEDGMENTS

This work has been supported by the STC 4.0 HP (New Generation of Stoneware Tableware in Ceramic 4.0 by High-Pressure Casting Robot work cell) Project with reference (POCI-01-0247-FEDER-069654-STC 4.0 HP), financed by ‘Fundo Europeu de Desenvolvimento Regional’ (FEDER), through the incentive system to I&DT, integrated into the ‘Programa Operacional Competitividade e Internacionalização’ (POSI), within the scope of Portugal 2020 and by FCT - Fundação para a Ciência e Tecnologia within the Project Scope: UIDB/05757/2020. The authors are grateful to the Foundation for Science and Technology (FCT, Portugal) for financial support through national funds FCT/MCTES (PIDDAC) to CeDRI (UIDB/05757/2020 and UIDP/05757/2020) and SusTEC (LA/P/0007/2021). Mariano Alvarez and Laiany Suganuma Brancalio thank FCT for the PhD Grant 2023.01113.BDANA and 2023.01441.BD.

This work was supported by RoboSteamSen Project, being founded, by the European commission through the Spanish National Agency for the Erasmus+ Programme.

REFERENCES

- Alvarez, M., Brancalião, L., Carneiro, J., Costa, P., Coelho, J. P., & Gonçalves, J. (2023). Automated ceramics tableware finishing: A laboratory prototype for concept validation.
- Alvarez, M., Brancalião, L., Carneiro, J., Costa, P., Coelho, J. P., & Gonçalves, J. (2023, September). Automated ceramics tableware finishing: Non-circular geometries case study. In IEEE International Conference on Emerging Technologies and Factory Automation (ETFA), 2023-September.
- Alvarez, M., Brancalião, L., Gomes, D., Pinto, V., Carneiro, J., Santos, J., Coelho, J. P., & Gonçalves, J. (2022). Prototyping and control of an automatic ceramic tableware finishing device. In *Lecture Notes in Electrical Engineering* (Vol. 930, LNEE).
- Alvarez, M., Brancalião, L., Carneiro, J., Costa, P., Coelho, J. P., & Gonçalves, J. (2024). Robustness increase of a ceramics finishing prototype: Towards meeting industry requisites. In J. A. d. C. Gonçalves, J. L. S. d. M. Lima, J. P. Coelho, F. J. García-Peñalvo, & A. García-Holgado (Eds.), *Proceedings of TEEM 2023* (pp. 493–503). Springer Nature Singapore.
- Brancalião, L., Alvarez, M., Coelho, J., Conde, M., Costa, P., & Gonçalves, J. (2024). Learning mobile robotics: An approach based on a classroom competition.
- Brancalião, L., Alvarez, M., Coelho, J., Conde, M., Costa, P., & Gonçalves, J. (2024). Programming mobile robots in an educational context: A hardware-in-the-loop approach.
- Brancalião, L., Conde, M. Á., Costa, P., & Gonçalves, J. (2022). Stochastic modelling of a time of flight sensor to be applied in a mobile robotics application. In L. Brito Palma, R. Neves-Silva, & L. Gomes (Eds.), *CONTROLO 2022* (pp. 621–632). Springer International Publishing.
- Brancalião, L., Alvarez, M., Conde, M., Costa, P., & Gonçalves, J. (2023). Towards a more accurate time of flight distance sensor to be applied in a mobile robotics application.
- Coelho, J., Brancalião, L., Alvarez, M., Costa, P., & Gonçalves, J. (2024). Modeling and control of an educational manipulator robot joint.

Study of Electro Discharge Machining (EDM) to manufacture holes in Selective Laser Melted (SLM) parts.

I Rodríguez-Fernández¹, J Alonso-Martínez², M A Castro-Sastre³, A I Fernández-Abia^{3*}

¹Escuela de Ingenierías Industrial, Informática y Aeroespacial, Universidad de León, 24071, León, España

²Unidad de Fabricación e Impresión 3D (UFI3D), módulo MIC, Universidad de León, 24071, León, España. ³Instituto Universitario de Investigación e Innovación en Ingeniería (I4), módulo MIC, Universidad de León, 24071, León, España

(*)**Email:** aifera@unileon.es

ABSTRACT

This study evaluates the performance of the Electro Discharge Machining (EDM) process on parts manufactured using Selective Laser Melting (SLM) technology. To achieve this purpose, holes were drilled into 17-4 PH stainless steel specimens produced by SLM, measuring the machining time and tool wear. The tests were repeated on specimens of the same material produced using conventional methods, and the results were compared. The findings indicate that SLM parts demonstrate superior performance. This study aims to enhance understanding of the capabilities and limitations of SLM in conjunction with EDM, with the objective of optimizing the parameters of both processes for specific industrial applications.

Keywords: Electro Discharge Machining (EDM); Selective Laser Melting (SLM); 17-4 PH Stainless Steel; Process Optimization.

INTRODUCTION

Within additive manufacturing processes, the powder bed fusion technology known as Selective Laser Melting (SLM), is one of the most important methods for producing metallic parts, notable for its ability to create high-density components with complex geometries. However, this process has limitations that can affect the final quality of the produced components. Among the main limitations are dimensional accuracy and surface finish, particularly in small geometries with very fine details. Generally, the SLM process produces a surface roughness Ra greater than 10 µm and a dimensional tolerance of 40-100 µm. In addition, this process has limitations when producing small diameter holes. Therefore, when the parts have high requirements, it is necessary to perform post-processing operations to obtain parts with close tolerances and good surface quality.

Electrical discharge machining (EDM) is a highly effective process for achieving high-precision finishes on hard and difficult-to-machine materials (Soori et al., 2024) This process is capable of machining any electrically conductive material, regardless of its mechanical properties of strength, hardness or brittleness. The EDM process is a popular manufacturing method for drilling large aspect-ratio holes (Sanchez et al., 2013), where the SLM process presents limitations.

To date, the interaction between the SLM and EDM processes has not been studied, which has the potential to open new possibilities in the production of mechanical components with specific requirements for precision and surface finish. This work investigates the behavior of

SLM-fabricated parts in the EDM process, evaluating the material removal rate and the wear experienced by the electrode. This analysis will help to understand the capabilities and limitations of the SLM in combination with EDM, with the aim of optimizing the parameters of both processes for specific industrial applications.

RESULTS

The tests consisted of drilling 5 mm deep holes on 17-4 PH austenitic stainless steel specimens, manufactured using SLM additive technology and commercial wrought material. Copper electrodes with a diameter of 2 mm were used for this purpose. The SLM samples were produced utilizing a ProX 100 SLM printer from 3DSYSTEMS. The printing parameters recommended by the manufacturer were used, including laser power of 38 W, scanning speed of 140 mm/s, layer thickness of 30 μm, hatch spacing of 70 μm and a hexagonal scanning strategy. The printing process was conducted in a nitrogen atmosphere, maintaining an oxygen level below 1000 ppm to prevent oxidation of the metal powder. Samples for wrought material were type 630, condition 1150, ASTM A564. The chemical composition for both materials is similar and is shown in Table 1. Despite the similar composition, the microstructure, and consequently the mechanical and electrical properties of the parts produced by both methods are different. (Garcia-Cabezon et al., 2023)

Table 1 - Chemical composition of the SLM and wrought 17-4 PH SS samples.

Elements	%C	%Cr	%Ni	%Mo	%Mn	%Si	%Cu	%Nb	%N	%S	%Al	%Fe
Wrought	0.032	15.70	4.30	0.15	0.61	0.27	3.13	0.255	0.004	0.0005	0.005	Bal.
Powder	0.038	16.93	4.17	-	0.58	0.62	3.56	0.21	0.072	0.005	-	Bal.

The electro-discharge machine used to perform the experimentation was an ONA mod. Techno C300. For the SLM specimens the EDM process was carried out in two different orientations, drilling the holes perpendicular and parallel to the build direction. The EDM parameters were kept constant during the experimentation, except for the current, which varied between 1 A and 2 A. All tests were repeated three times, measuring the machining time and the tool wear. Figure 1 shows the times required to drill 5 mm deep holes for the three types of samples tested, using two different current values.

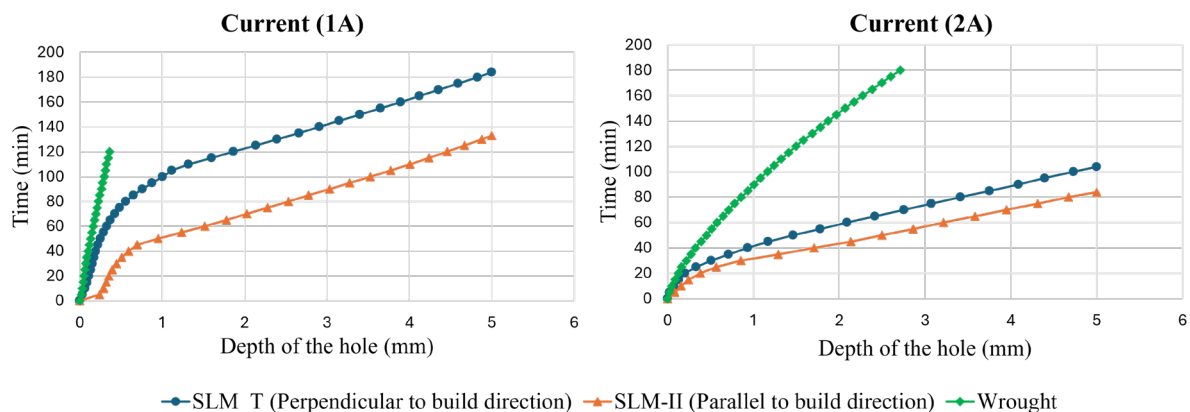

Figure 1- Time machining vs depth of the hole.

The graphs show that machining times are shorter when the current is 2 A, as expected. For the wrought material, the drilling did not reach the 5 mm depth with either current, as the process was halted due to excessive erosion times. Additionally, machining times are shorter for samples drilled parallel to the built direction (SLM_II), with the most noticeable difference occurring at 1 A.

Figure 2 illustrates the relationship between the depth of the hole and the tool wear. As expected, tool wear is greater for tests conducted at a current of 2 A. For tests performed perpendicular to the build direction, tool wear is notably higher at 2 A. In the case of conventional material, the tool wear relative to the depth of the holes is significantly greater compared to the tests conducted with SLM specimens.

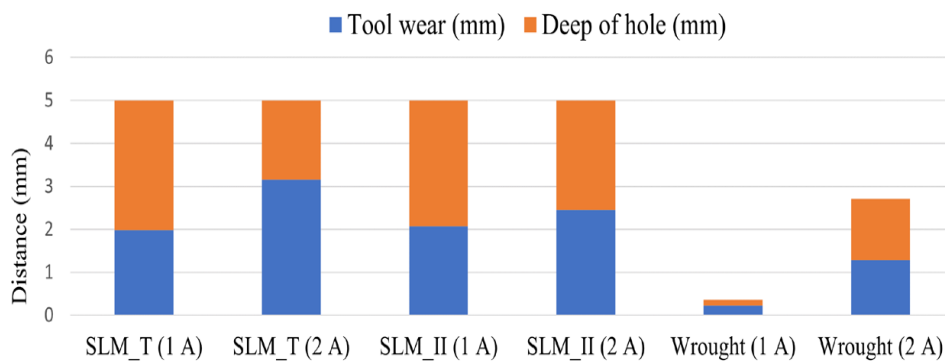

Figure 2- Time machining vs depth of the hole.

CONCLUSIONS

The results showed significant differences in the EDM behavior of 17-4 PH stainless steel processed by SLM in comparison to the commercial wrought material. The parts produced by SLM showed a higher material removal rate and lower tool wear, which is attributed to differences in microstructure and electrical resistivity. The parts produced by SLM showed a higher material removal rate and lower tool wear, which is attributed to differences in microstructure and electrical resistivity due to the manufacturing process. Additionally, it was observed that when the erosion process is performed parallel to the build direction, slightly shorter erosion times are achieved, resulting in better process performance. It was also noted that higher current increases the material removal rate but also raises tool wear, suggesting the need to balance both factors to optimize the process.

Further research is needed to better understand the interaction between the SLM and EDM processes, which will contribute to the development of hybrid techniques where material addition is combined with material removal in areas of the parts that require tight tolerances and high-quality surface finishes.

ACKNOWLEDGMENTS

The support of the UFI 3D Laboratory at the University of León in Spain.

REFERENCES

Garcia-Cabazon C., García Hernández C., Castro-Sastre M.A., Fernandez-Abia A.I., Rodriguez-Mendez M.L., Martin-Pedrosa F., Heat treatments of 17-4 PH SS processed by SLM to improve its strength and biocompatibility in biomedical applications. *Journal of Materials Research and Technology*, 2023. 26: p. 3524-3543.

Sánchez J.A., Plaza S., Gil R., Ramos J.M., Izquierdo B., Ortega, N., Pombo I., Electrode Set- Up for EDM-Drilling of Large Aspect-Ratio Microholes. *Procedia CIRP*, 2013. 6: p. 274-279.

Soori M., Karimi F., Jough G., Minimization of residual stress, surface roughness and tool wear in Electro Discharge Machining of inconel 625. *Journal of Engineering Research*, 2024. <https://doi.org/10.1016/j.jer.2024.05.028>.

Utilisation of feedstock material in additive manufacturing technology of ceramics by UV laser vat-photopolymerisation (VPP-UVL/C)

S. Peláez-Peláez^{1,*}, A. Martínez-Sánchez¹, S. Giganto¹, P. Rodríguez-González¹, S. Martínez-Pellitero¹

¹Area of Manufacturing Process Engineering, Universidad de León, 24071, León, Spain

(*) **Email:** spelp@unileon.es

ABSTRACT

Additive manufacturing (AM) represents a revolution in the industry by enabling the production of parts with complex geometries and a high degree of customisation, optimising the use of materials and reducing waste. Moreover, it has significant benefits in terms of sustainability, reducing waste and reducing the carbon footprint by up to 70%. In the field of ceramic materials, the use of AM technologies has gained relevance by combining the advantages of additive manufacturing with the properties of ceramics, however, research on sustainability is very limited.

Among the AM techniques for ceramics, UV laser vat-photopolymerisation (VPP-UVL) stands out for its precision and finish quality, but in terms of sustainability it presents major challenges such as post-process optimisation, emission assessment and material sustainability. In particular, this work focuses on the optimisation of material usage through the design and development of a functional prototype of the feed deposit for the Ceramaker 900-FLEX machine of 3DCeram Sinto Group, aimed at the production of small parts and/or short batches, optimising its use and reducing waste, especially important in materials with an expiry date.

Keywords: Additive Manufacturing (AM); Sustainability; Ceramic Materials; Vat-Photopolymerisation (VPP-UVL).

INTRODUCTION

Additive manufacturing (AM) is a transformative method where components are constructed from digital models through the consecutive deposition of material, typically layer by layer, in contrast to traditional subtractive or formative manufacturing techniques. This innovative approach represents a paradigm shift in the industry, enabling the production of functional parts with intricate geometries, a high degree of customisation, and excellent dimensional accuracy, all while optimising material usage and minimising waste. From a sustainability perspective, AM is reshaping the production landscape by significantly reducing material waste and lowering the carbon footprint by up to 70% compared to conventional methods (Mehrpooya et al., 2021). This makes AM a greener and more economical alternative, particularly for manufacturing small batches, customised products, or components with complex structures. As industries increasingly prioritise sustainable practices, AM is emerging as a key enabler of eco-friendly manufacturing.

In recent years, there has been a surge of interest in applying AM technologies to ceramics, combining the advantages of AM with the unique properties of ceramic materials, such as high thermal stability, chemical resistance, and mechanical strength. This synergy has unlocked new opportunities across a wide range of applications, including tissue engineering, catalyst

supports, hot gas filtration membranes, energy conversion and storage systems, and electronic components (Diao Q. et al., 2024). Among the various AM techniques used for ceramics, UV laser vat-photopolymerisation (VPP-UVL) has gained prominence due to its ability to produce parts with high precision, superior surface finish, and enhanced mechanical properties (Schwentenwein M. et al., 2015).

Despite these technological advancements, there remains a significant gap in research addressing the integration of sustainability principles into ceramic AM processes (Fantozzi G. et al., 2024), particularly when using VPP-UVL technology. This gap highlights the need for further exploration into how sustainable practices can be embedded into the development and application of ceramic AM, ensuring that the environmental benefits of AM are fully realised in this specialised field. Addressing this challenge could pave the way for more sustainable manufacturing practices, aligning with global efforts to reduce environmental impact and promote circular economy principles.

Among the different challenges presented by this technology to create sustainable practices such as the optimisation of post-processes (as they consume a lot of energy), the correct evaluation of the emissions generated during the entire manufacturing process and the improvement of the sustainability of the materials, this work focuses on offering a solution to the optimisation of the use of the material. To this purpose, we propose the implementation of a feed deposit for the 3DCeram Sinto Group's Ceramaker 900-FLEX machine, which is adaptable according to the material required. Currently, this machine has a feed deposit with a capacity of 305 x 124 x 200 mm. For each print, the initial volume of material to be filled is adapted solely according to the height of the highest part by adjusting the feed piston or Z-axis (Figure 1.b). However, in certain situations where it is not necessary to use the entire build plate, unnecessary consumption is generated by requiring the distribution of material over the entire working area, as shown in Figure 1.a. Although this 'unused' material can be reused, it is not possible to recover it in its entirety due to the high viscosity of the materials used in this technology, which tends to adhere to different components of the machine. Moreover, its exposure to the environment reduces its useful life from 6 to 3 months, which accelerates its expiry.

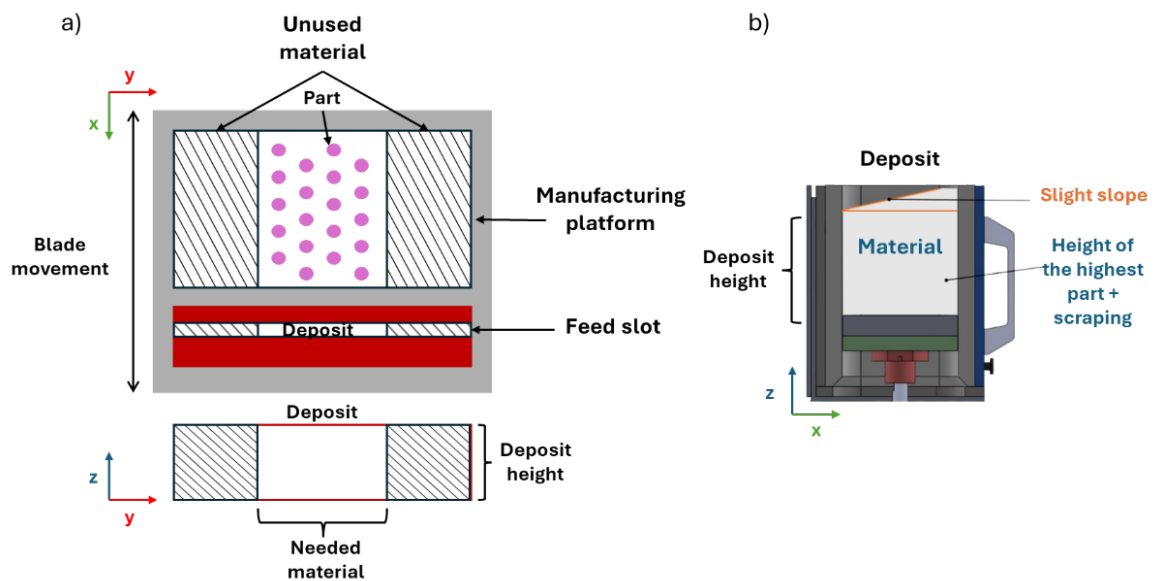

Figure 1 - a) Schematic representation of material wastage from the top view of the deposit and the manufacturing area and front of the deposit. b) Schematic representation of the loading of the deposit material from a side view (Modified from 3DCeram Sinto Group).

For this work, a functional prototype of the PLA reservoir has been fabricated using the material extrusion (MEX) AM technique aimed at small parts and small batches.

RESULTS

To improve material utilisation, a functional prototype of a deposit and piston has been developed, the dimensions of which are detailed in Figure 2-a. This prototype has been manufactured by the extrusion process (MEX) using the Ultimaker S2+ machine and PLA material. Subsequently, a surface finishing treatment was applied, which consisted of sanding followed by a dichloromethane vapour bath, to eliminate the staircase effect characteristic of this technology and to avoid the deposition of material residues on the prototype. Finally, tests were carried out with this prototype, achieving the manufacture of parts in the central area of the table, optimising the use of the material with satisfactory results.

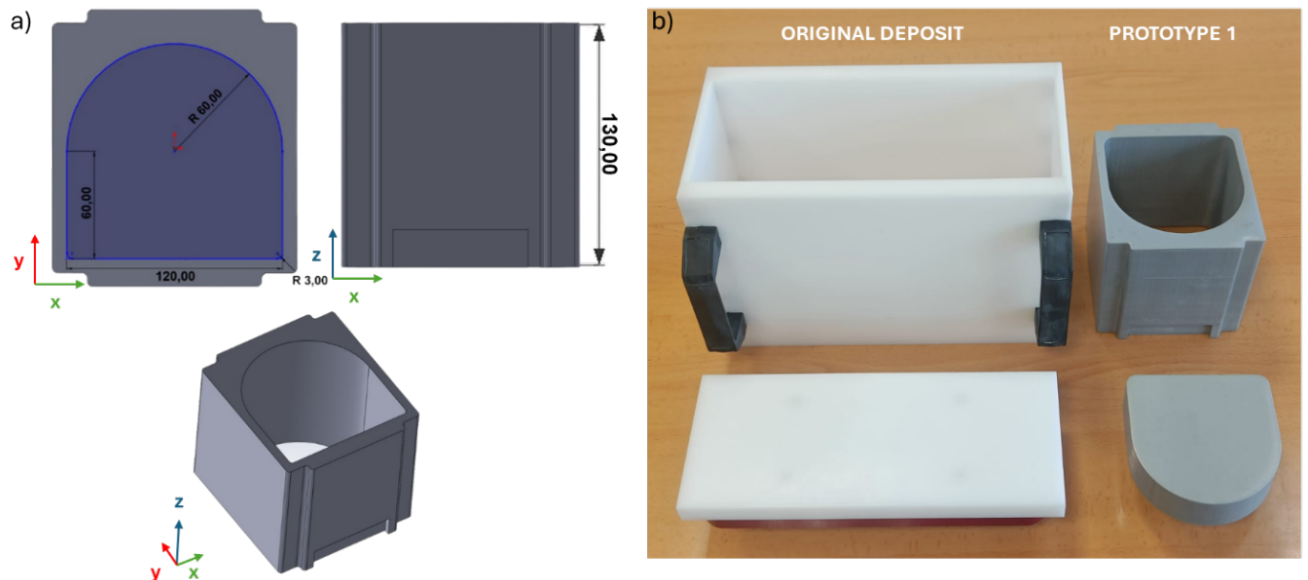

Figure 2 - a) Schematic representation of the designed prototype with dimensions in mm. b) Comparison between the original deposit-piston assembly and the prototype of the manufactured assembly.

CONCLUSIONS

Due to the increasing interest in various sectors, the AM of ceramic parts has become more and more relevant in recent years. However, there is a need for further research on the sustainability associated with these technologies, particularly in VPP-UVL/C technologies. In the present work, one of the main problems of these technologies has been addressed, specifically in the Ceramaker 900-FLEX machine, by developing a successful prototype that optimises the use of the material. Currently, a modular deposit-piston assembly has been designed that will allow a better adaptation to the specific requirements of the parts to be manufactured (size and quantity), thus contributing to overcome this challenge.

ACKNOWLEDGMENTS

Grant PID2021-125992OB-I00 funded by MICIU/AEI/10.13039/501100011033 and FEDER/UE.

REFERENCES

Mehrpouya M., Vosooghnia A., Dehghanghadikolaei A., and Fotovvati B., The benefits of additive manufacturing for sustainable design and production, *Sustainable Manufacturing*, 2021, p. 29–59.

Diao Q., Zeng Y., and Chen J., The applications and latest progress of ceramic 3D Printing, *Additive Manufacturing Frontiers*, 2024, 4 (1).

Schwentenwein M., and Homa J., Additive Manufacturing of Dense Alumina Ceramics, *International Journal of Applied Ceramic Technology*, 2015, 12 (1): p. 1–7.

Fantozzi G., Villa A., Kumar P., Gianchandani, and F. Baino, Sustainable Approaches for the Additive Manufacturing of Ceramic Materials, *Ceramics*, 2024, 7(1): p. 291-309.

MEX and VPP-UVL Technologies for Printing Complex Alumina Parts

A. Martínez-Sánchez^{1,*}, S. Peláez-Peláez¹, D. Álvarez-Rubio¹, J. Barreiro¹

¹Area of Manufacturing Process Engineering, Universidad de León, 24071, León, Spain

(*) **Email:** amarts@unileon.es

ABSTRACT

This study explores the advantages and disadvantages of manufacturing complex-shaped alumina parts through Material Extrusion (MEX) compared to Vat Photopolymerization via Ultraviolet Laser exposure (VPP-UVL), by evaluating key printing parameters and post-processing techniques. For the MEX printing technique, optimal printing parameters, such as nozzle temperature and print speed, were determined along with their influence on surface quality and dimensional accuracy of the parts. It is concluded that, although challenges such as interlayer bonding and porosity exist, alumina extrusion 3D printing can replace VPP-UVL printed parts in certain industrial applications

Keywords: Material Extrusion (MEX); Vat Photopolymerization (VPP-UVL); Alumina Parts; Printing Parameters.

INTRODUCTION

As it is widely known, the excellent mechanical properties, thermal resistance, and chemical stability of alumina (Tosto et al., 2022), make this material an ideal choice for high-demand industrial applications, such as electronics and chemical engineering (Parikh, 1995). Additive manufacturing has revolutionised the way complex parts are created, reducing costs and lead times compared to traditional methods. Among the various 3D printing processes, Material Extrusion (MEX) has proven to be a viable technique for producing ceramic components, particularly using alumina (Al_2O_3). It is an accessible and cost-effective technology. On the other hand, VPP-UVL technology has shown to be more precise, capable of producing parts with a high level of detail and superior surface quality (Bove et al., 2022). However, this technique is more expensive, more complex, and generates more waste than MEX. Both technologies require post-processing (debinding and sintering) to enhance the final properties of ceramic parts (Li et al., 2020).

In this study, a Bambulab X1 Carbon printer was used to evaluate the feasibility of printing with Zetamix Nanoe alumina filament through Material Extrusion (MEX). First, test pieces were printed to analyse dimensional accuracy and surface quality, adjusting parameters such as nozzle temperature and print speed. Additionally, the impact of the type of print surface on interlayer adhesion and part quality was evaluated. For alumina printing via VPP-UVL, a 3D CERAM C900 Flex machine was used with material supplied by the same manufacturer. Finally, complex lattice geometries were fabricated to compare both technologies (MEX and VPP-UVL).

RESULTS

Based on the printing results of the test pieces, the most suitable parameters were established: nozzle temperature of 160°C, bed temperature of 20°C, layer height of 0.24 mm, retraction speed of 20 mm/s, the use of a smooth print platform, and a nozzle diameter of 0.6 mm. For the VPP-UVL process, following the manufacturer's recommendations, a layer height of 50 µm was used. Figure 1 shows the stages of both processes.



Figure 1 - Manufacturing stages for producing alumina parts using MEX and VPP-UVL.

In MEX technology, a filament with a diameter of 1.75 mm consisting of 83% alumina and 17% binder is used, while in VPP-UVL, a paste of alumina particles dispersed in an organic medium is employed. After printing parts using VPP-UVL, the cleaning stage is critical due to the fragility of the green parts. On the other hand, MEX printing requires a pre-debinding stage in an acetone bath to remove part of the organic material. Following this, both technologies require a debinding stage to eliminate the organic material (Table 1) and a sintering stage for final densification (Table 2).

Table 1 – Comparison of the Debinding Cycle for both processes.

	VPP-UVL			MEX		
	Temperature (°C)	Ramp (°C/min)	Holding time (min)	Temperature (°C)	Ramp (°C/min)	Holding time (min)
1	20-240	0,2	20	20-125	0,583	/
2	240-260	0,1	20	125-200	0,833	/
3	460-800	0,3	120	200-215	0,367	/
4	800-1.050	1	5	215-250	0,183	/
5	1.050-20	2	/	250-280	0,333	/
6				280-320	0,133	/
7				320-510	0,400	/

Table 2 – Comparison of the Sintering Cycle for both processes.

	VPP-UVL			MEX		
	Temperature (°C)	Ramp (°C/min)	Holding time (min)	Temperature (°C)	Ramp (°C/min)	Holding time (min)
1	20-1.250	3	/	20-1.550	0,833	120
2	1.250-1.700	2	90	1.550-20	1,667	/
3	1.700-20	3	/			

The sintering cycle causes anisotropic shrinkage in the final parts, which is greater for the MEX technology (Table 3).

Table 3 - Anisotropic shrinkage after sintering of parts manufactured by both technologies.

Technology	Shrinkage in X	Shrinkage in Y	Shrinkage in Z
MEX	20,76%	20,76%	23,19%
VPP-UVL	14,32%	12,90%	15,31%

Complex alumina parts were successfully manufactured using MEX, as shown in Figure 1, although some layer separation was observed. Additionally, the limitations of this technology prevent the use of outer wall thicknesses below 1.2 mm. In comparison, parts manufactured via VPP-UVL could be produced with thicknesses of 0.5 mm, and exhibited better interlayer adhesion, lower porosity, and greater dimensional accuracy.

CONCLUSIONS

Although parts printed using MEX exhibit lower quality compared to those produced by VPP-UVL, this technology has proven capable of manufacturing complex-shaped parts at a

significantly lower cost. This advantage makes MEX a competitive option for certain industrial applications where higher porosity is prioritised over dimensional and surface accuracy, such as in catalyst supports. Therefore, the choice between the two technologies will depend on the final application, considering the results obtained, cost, and limitations of each process.

ACKNOWLEDGEMENTS

This work has been supported by the Junta de Castilla y León and the Ministry of Science and Innovation MICIN and the European Union NextGenerationEU/PRTR (H2MetAmo-C17.I01.P01.S21), as well as by the project PID2021-125992OB-I00 funded by MICIU/AEI/10.13039/501100011033 and FEDER/UE.

REFERENCES

- Bove, A., Calignano, F., Galati, M. and Iuliano, L. (2022) "Photopolymerization of Ceramic Resins by Stereolithography Process: A Review", *Applied Sciences* 2022, Vol. 12, Page 3591. Multidisciplinary Digital Publishing Institute, 12(7), p. 3591. doi:10.3390/APP12073591.
- Li, H., Liu, Yong Sheng, Liu, Yan Song, Zeng, Q. F., Hu, K. H., Liang, J. J. and Lu, Z. G. (2020) "Microstructure and properties of 3D-printed alumina ceramics with different heating rates in vacuum debinding", *Rare Metals. University of Science and Technology Beijing*, 39(5), pp. 577–588. doi:10.1007/S12598-020-01372-X/FIGURES/15.
- Parikh, P. B. (1995) "Alumina Ceramics: Engineering Applications and Domestic Market Potential", *Transactions of the Indian Ceramic Society. Taylor & Francis*, 54(5), pp. 179–184. doi:10.1080/0371750X.1995.10804716.
- Tosto, C., Bragaglia, M., Nanni, F., Recca, G. and Cicala, G. (2022) "Fused Filament Fabrication of Alumina/Polymer Filaments for Obtaining Ceramic Parts after Debinding and Sintering Processes", *Materials* 2022, Vol. 15, Page 7399. Multidisciplinary Digital Publishing Institute, 15(20), p. 7399. doi:10.3390/MA15207399.

Design of a novel bi-phasic biomimicking auxetic 3d printed structure with fluids that biomimic the hysteretic behaviour of articular cartilage for medical phantoms

N A T C Fernandes¹, F Silva¹, A Leal¹, O Carvalho¹

¹Center for Microelectromechanical Systems, Universidade do Minho, 4800-058, Guimarães, Portugal

(*)**Email:** nnunofernandes@dem.uminho.pt

ABSTRACT

This study aims to develop a novel bi-phasic, 3D-printed structure for medical phantoms that biomimics the dynamic, hysteretic behaviour of soft tissues. Traditional medical phantoms are effective at simulating static mechanical biological tissue properties but often fail to replicate the complex biomechanical characteristics of biological tissues, such as viscoelasticity, anisotropy, and fluid-solid interactions. By utilizing 3D printing and embedding fluid components, this research seeks to overcome these limitations. The designed structure will more accurately simulate biological tissues' response under mechanical load, including energy dissipation through hysteresis. This advancement in medical phantom technology offers potential for more realistic testing and validation of medical devices, imaging techniques, and treatments related to biological tissues, ultimately improving patient care.

Keywords: 3D-Printed Medical Phantoms; Biomechanical Biomimicry; Viscoelasticity; Hysteresis.

INTRODUCTION

Medical phantoms are vital in the development and validation of medical devices, particularly for imaging and diagnostic technologies (Vasilev et al. 2023). They enable researchers to validate and optimize new techniques, assess image quality, and test equipment, ensuring devices are safe and effective before patient use. Phantoms also provide a risk-free environment for medical training and skill development, allowing unlimited practice of procedural techniques (Chambers, Schartung, and Resuehr 2023). They aid in quality control by optimizing clinical protocols and improving image reconstruction. Phantoms, made more realistic through advanced manufacturing, offer a cost-effective alternative to early-stage clinical trials and contribute to standardization in device performance evaluation, supporting regulatory approval and maintaining quality standards in healthcare (Salmi 2021).

Simulating human tissues, including soft tissues, is crucial for medical imaging and therapeutic applications, and medical phantoms play a key role in this process. These phantoms often utilize polymeric biomaterials such as PMMA, polystyrene, polyethylene, and polypropylene, with PMMA showing particularly promising results in radiation therapy (Ekinici et al. 2023). Designed to replicate important physical (density, elasticity, compressibility), chemical (water content, GAG concentration), and imaging properties (MRI signal intensity, X-ray attenuation, ultrasound echogenicity), phantoms enhance realism through techniques like mimicking sodium concentration and proton T1/T2 relaxation times, which relate to proteoglycan loss (Li et al. 2007). Validation through imaging comparisons, mechanical testing, and chemical analysis ensures their accuracy, allowing for the safe development of imaging techniques, treatments,

and therapeutical devices without human subjects in early research stages.

Simulating the dynamic behaviour of soft tissues in medical phantoms remains a challenge, as most current phantoms are designed to replicate static properties rather than the complex biomechanical characteristics of living tissues. The material described above are commonly used to mimic soft tissues, but they fall short in capturing soft tissues' viscoelasticity, anisotropy, and fluid-solid interactions (S.A. Khristianovich and Denisova 2022). The human body soft tissues unique properties, such as its combination of viscous and elastic behaviours and its water content (Figure 1), are difficult to simulate. However, advancements in phantom technology, such as multi-material 3D printing (Yin et al. 2021), tissue-mimicking materials (Bootsma et al. 2016), and computer-aided design (Ha et al. 2017), offer potential solutions. These innovations could lead to more accurate representations of soft tissues, but fully capturing its dynamic responses remains a challenge. For now, phantoms are primarily used for static simulations or basic mechanical testing, with ongoing research aiming to improve their capabilities.

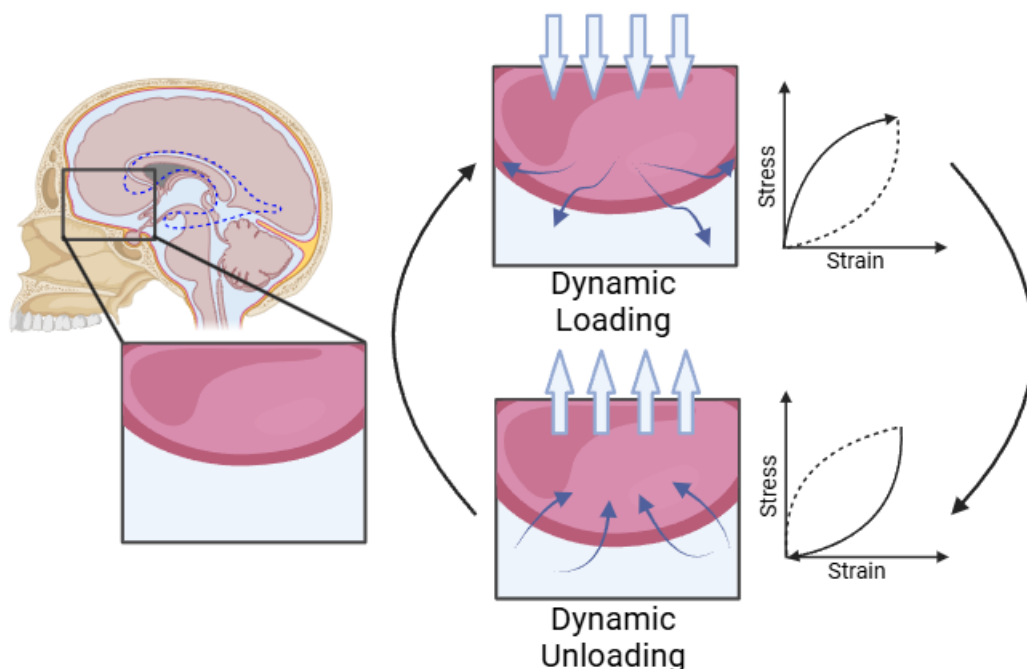

Figure 1 - Illustration of brain tissue deformation under dynamic loading and unloading conditions, showing stress-strain relationships during compression and relaxation phases.

In this study, we will design a novel bi-phasic, 3D-printed structure that biomimics the hysteretic behaviour of soft tissues for use in medical phantoms. This structure will incorporate both solid and fluid components, accurately reflecting the viscoelastic and anisotropic properties of soft tissues. By embedding fluids within the design, we aim to replicate the dynamic fluid-solid interactions that are key to soft tissues response under dynamic load, including its ability to dissipate energy through hysteresis. This approach will allow for more realistic simulations of soft tissues' dynamic mechanical behaviour, providing a valuable tool for the development and testing of medical devices and therapeutic techniques.

RESULTS

Thermoplastic polyurethane (TPU) was chosen as the 3D printing material for its flexibility, enabling the creation of an auxetic structure with a negative Poisson's ratio, allowing for compression without excessive elongation. This structure, inspired by biological tissues (Black et al., 2023), consists of two layers connected by diagonal beams that compress along one axis while limiting elongation along the other (Figure 1). Additionally, several cavities are included to facilitate fluid flow between the layers, simulating the fluid movement typical in biological tissues. Multiple iterations of the meta-material design, incorporating various auxetic cell structures, were extensively tested and analyzed. Adjustments were made to optimize the geometric configuration and print parameters to ensure structural fidelity. Through this iterative process, we refined both the design and 3D printing settings until the printer consistently produced the desired structure with high accuracy and no loss of detail (Figure 2, Figure 3, and Figure 4).

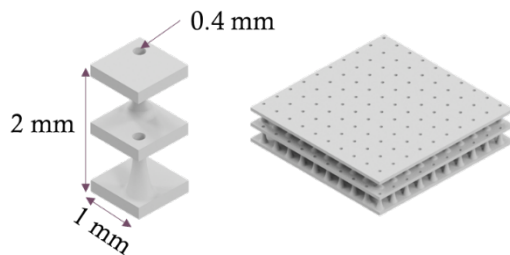

Figure 2 - Initial 3D-printed auxetic cell structure.

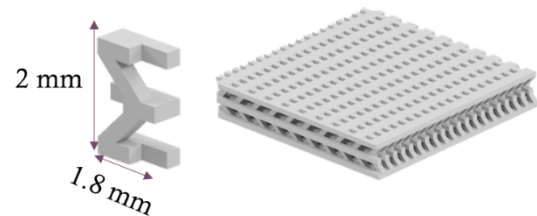

Figure 3 - Intermediate iteration of the auxetic meta-material, showing improved fidelity resulting in reduced printing defects compared to earlier designs.

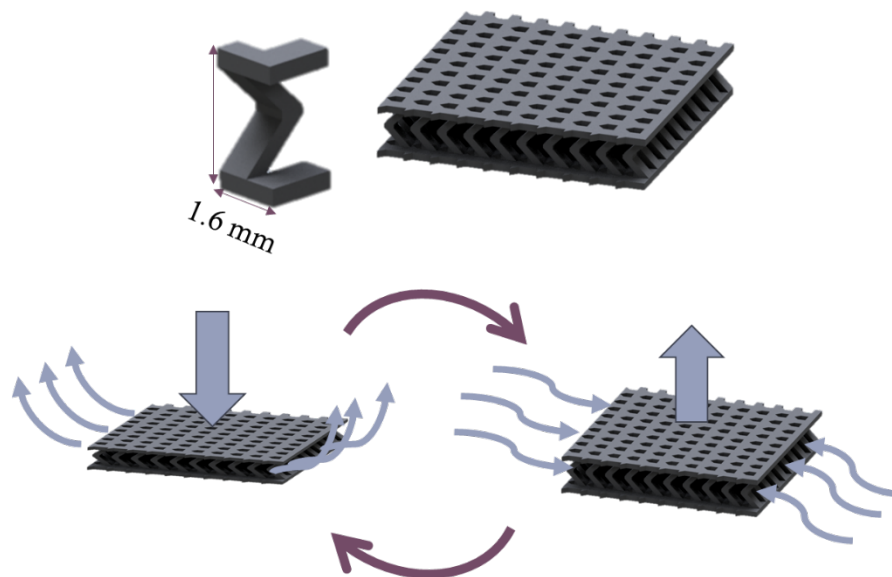

Figure 4 - Final optimized 3D-printed meta-material design, with an accompanying schematic illustrating the integrated fluid flow mechanism for mimicking water inflow and outflow under mechanical loading.

A Multiphysics simulation was conducted to analyse the interaction between the solid structure and the fluid flow within the bi-phasic design. Using a solid-fluid interface solver, the simulation modelled how fluid moves between the layers of the auxetic structure during compression, closely mimicking the fluid-solid interactions seen in biological tissues. This approach allowed us to study the impact of fluid movement on the overall mechanical behaviour of the structure, particularly how the fluid flow contributes to the hysteretic response under load. The results of this simulation provide valuable insights into the dynamic behaviour of the bi-phasic material, highlighting the crucial role that fluid flow plays in replicating the viscoelastic properties of biological tissues. These findings further validate the potential of combining 3D printing and advanced simulation techniques to create more accurate and functional medical phantoms (Figure 5).

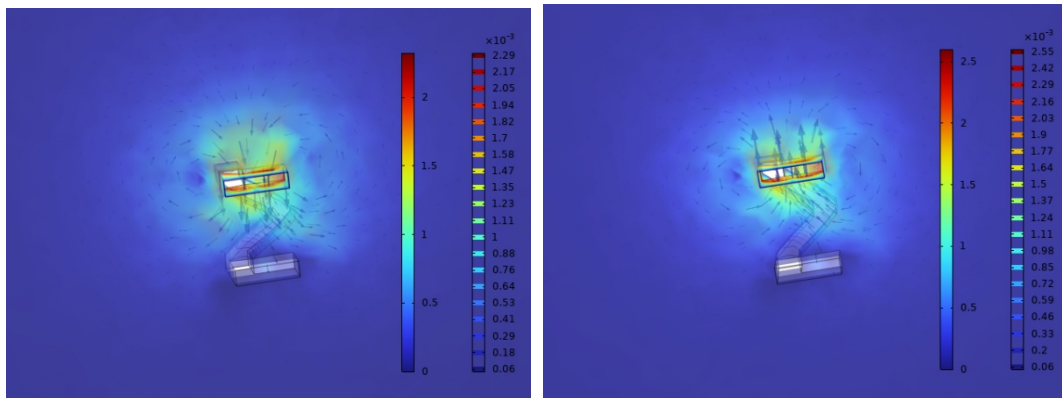

Figure 5 - Solid-fluid simulations of a unitary cell.

The hysteretic behavior of the meta-material was clearly demonstrated, as shown in Figure 6, where the stress-strain curve exhibits characteristic energy dissipation loops. This response highlights the significant influence of the fluid environment, which contributed to the overall viscoelastic properties of the system. The observed behavior closely mimics the natural dynamic response of biological tissues under mechanical loading, validating the design's ability to replicate key biomechanical characteristics.

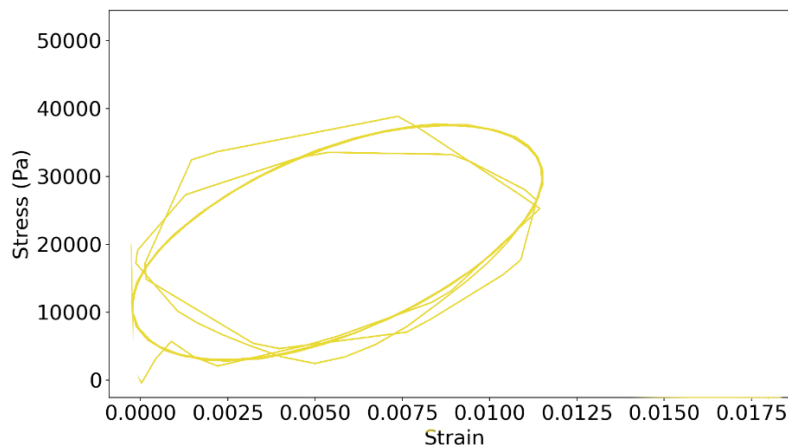
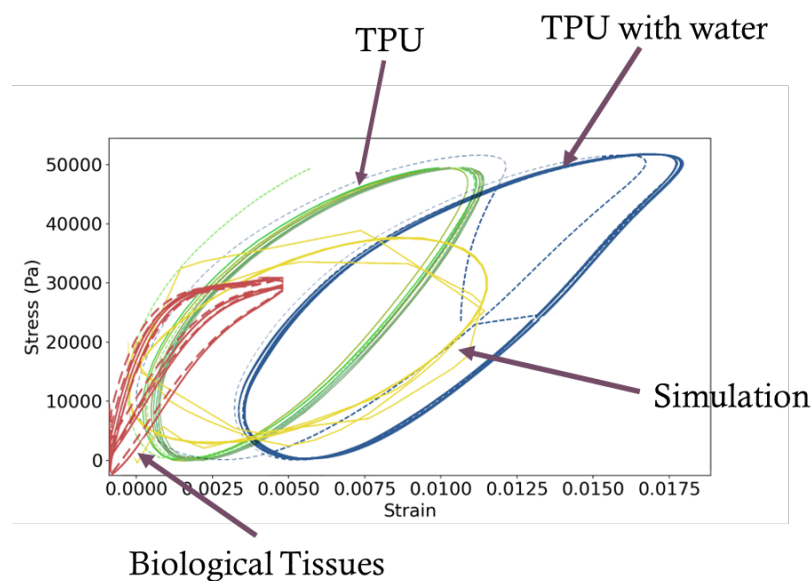

Figure 6 - Resulting hysteretic behaviour in the simulation.

Experimental tests were performed resorting to a shaker, exciting the system at 10 Hz. The experimental results demonstrated that the structures exhibit hysteretic behavior, indicating effective energy dissipation characteristics. Although the behavior does not perfectly match that of natural biological tissues, it falls within a similar range. With further optimization, it is feasible to achieve a closer replication of biological tissues properties. The current experimental study focused only on solid structure, without considering fluid interaction. Experimental findings suggest that incorporating a fluid-solid interface could significantly alter and potentially enhance the behavior of the material, bringing it closer to the desired natural biological tissues response.

**Figure 7** - Hysteretic behaviour of the experimental results compared with the simulation.

CONCLUSIONS

The results show strong potential for combining 3D printing with medical phantoms, particularly in capturing the hysteretic behaviour of biological tissues using a bi-phasic material. By utilizing TPU and an auxetic structure, we successfully mimicked biological tissues' key biomechanical properties, including compression and fluid flow. Optimizing design angles reduced stress concentration and resistance to compression, highlighting the feasibility of this approach. These findings suggest that 3D printing can effectively create biomimetic structures that simulate the complex behaviour of biological tissues, offering promising applications for medical device development and therapeutic testing.

ACKNOWLEDGMENTS

This work is under the national support to R&D unit's grant through the reference project UIDB/04436/2020 and UIDP/04436/2020 and through the project "Mechanobiological device to stimulate cartilage regeneration" with grant reference PTDC/EME-EME/4520/2021. N A T C Fernandes acknowledges the support from FCT for his individual PhD grant with reference

2022.11063.BD. O Carvalho acknowledges the project “Mapping and modeling the transmission profile of optical and mechanical stimuli in the brain to optimize transcranial stimulation to combat neurological and psychiatric diseases” with grant reference PTDC/EME-EME/1681/2021

REFERENCES

- Bootsma, Katherine, Elizabeth Dimbath, Jason Berberich, and Jessica L. Sparks. 2016. ‘Materials Used as Tissue Phantoms in Medical Simulation’. In . *Studies in Mechanobiology, Tissue Engineering and Biomaterials*. Berlin, Heidelberg: Springer Berlin Heidelberg. https://doi.org/10.1007/8415_2016_1.
- Chambers, Mary E., David F. Schartung, and David Resuehr. 2023. ‘A 3D-Printed Forearm Trainer for the Practice of Ultrasound-Guided Arterial and Venous Line Placement’. *EMJ Dermatology*, November. <https://doi.org/10.33590/emjinnov/10300398>.
- Ekinci, Fatih, Erkan Bostanci, Mehmet Serdar Güzel, and Özlem Dagli. 2023. ‘A Monte Carlo Study for Soft Tissue Equivalency of Potential Polymeric Biomaterials Used in Carbon Ion Radiation Therapy’. *Nuclear Technology* 209 (8): 1229–39. <https://doi.org/10.1080/00295450.2023.2188144>.
- Ha, Jennifer F., Robert J. Morrison, Glenn E. Green, and David A. Zopf. 2017. ‘Computer-Aided Design and 3-Dimensional Printing for Costal Cartilage Simulation of Airway Graft Carving’. *Otolaryngology–Head and Neck Surgery* 156 (6): 1044–47. <https://doi.org/10.1177/0194599817697048>.
- Li, X., C. Benjamin Ma, T.M. Link, D.-D. Castillo, G. Blumenkrantz, J. Lozano, J. Carballido-Gamio, M. Ries, and S. Majumdar. 2007. ‘In Vivo T1ρ and T2 Mapping of Articular Cartilage in Osteoarthritis of the Knee Using 3T MRI’. *Osteoarthritis and Cartilage* 15 (7): 789–97. <https://doi.org/10.1016/j.joca.2007.01.011>.
- S.A. Khristianovich, and N.V. Denisova. 2022. ‘Computational Phantoms for Medical Radiology’. *MEDICAL RADIOLOGY AND RADIATION SAFETY* 67 (6): 51–61. <https://doi.org/10.33266/1024-6177-2022-67-6-51-61>.
- Salmi, Mika. 2021. ‘Additive Manufacturing Processes in Medical Applications’. *Materials* 14 (1): 191. <https://doi.org/10.3390/ma14010191>.
- Vasilev, Yuriy A., Olga V. Omelyanskaya, Anastasia A. Nasibullina, Denis V. Leonov, Julia V. Bulgakova, Dina A. Akhmedzyanova, Yuliya F. Shumskaya, and Roman V. Reshetnikov. 2023. ‘Anthropomorphic Breast Phantoms for Radiology Imaging: A Review’. *Digital Diagnostics* 4 (4): 569–92. <https://doi.org/10.17816/DD623341>.
- Yin, Jun, Manqi Li, Guangli Dai, Hongzhao Zhou, Liang Ma, and Yixiong Zheng. 2021. ‘3D Printed Multi-Material Medical Phantoms for Needle-Tissue Interaction Modelling of Heterogeneous Structures’. *Journal of Bionic Engineering* 18 (2): 346–60. <https://doi.org/10.1007/s42235-021-0031-1>.

Developing optical mimicking phantoms of the head tissues – a new approach for transcranial photobiomodulation research

Filipa Fernandes^{1*}, Filipe S. Silva^{1,2}, Nuno Sousa^{3,4}, Susana O. Catarino^{1,2}, Óscar Carvalho^{1,2}

¹ Center for Micro-ElectroMechanical Systems (CMEMS-UMINHO), University of Minho, Guimarães, Portugal

² LBBELS—Associate Laboratory, Braga/Guimarães, Portugal

³ Life and Health Sciences Research Institute (ICVS/3BS), PT Government Associate Laboratory, 4710-057 Braga

⁴ 2CA-Braga, CVS/3BS, PT Government Associate Laboratory, 4710-057 Braga, Portugal

(*) **Email:** id10486@alunos.uminho.pt

ABSTRACT

Transcranial photobiomodulation (tPBM) has gained relevance in the recent decade, due to positive results in clinical trials for several neurological pathologies (e.g., stroke, traumatic brain injury, dementia related diseases). Nonetheless, the uncertainty around the ideal light parameters causes some resistance in the incorporation of this therapy into mainstream practice (Fernandes, Oliveira, et al., 2024). To establish optimal stimulation parameters, it is important to first understand how light interacts with the relevant tissue, but using biological tissues for this research involves several ethical considerations and may be wasteful. Thus, to provide better alternatives for tPBM research, optical mimicking phantoms were developed using low-cost and sustainable materials. Agarose was used as matrix to which titanium dioxide (TiO₂); India ink; organometallic compounds; and laser-ablated gold and zinc were added.

The transmittance and reflectance spectra of the phantoms and porcine tissues (i.e., skin, muscle, cranium, brain, and cerebellum) were characterized using an integrating sphere, and later compared to find similarities between the two. Overall, it was possible to establish similarities between the porcine tissues and the phantoms' optical properties, but it was noted that finding a phantom that could replicate both the reflectance and absorbance spectra of a given tissue might be a difficult task. Further studies are required to study different concentrations and combinations of the materials to more closely mimic the optical properties of the biological tissues.

Keywords: Transcranial Photobiomodulation (tPBM); Optical Mimicking Phantoms; Agarose Matrix; Tissue Optical Properties.

INTRODUCTION

tPBM is a non-invasive, non-destructive and safe alternative therapy for some neurological pathologies. It concerns the application of light to the scalp, in the red to infrared wavelengths (600 to 1100 nm), which has been shown to have metabolic effects at the mitochondria, resulting in greater adenosine triphosphate (ATP) production, cerebral oxygenation, and cytoprotective, antioxidant, and apoptotic effects in cells (Hamblin, 2016; Salehpour et al., 2018).

However, it is still not certain which light parameters, such as, wavelength, frequency, power density, total energy delivered, and therapy parameters, e.g., location of stimulation, frequency of treatments, provide the ideal conditions for each patient and corresponding pathology.

Optical mimicking phantoms were developed to provide an alternative for tPBM research, without the constraints of using biological tissues. These phantoms can be used for studies of light propagation, enabling the study of several combinations of light parameters, without concerns of safety and invasive measurement of light penetration.

Agarose was used as the structural matrix for the phantoms since it is inexpensive and easy to use. The literature standards TiO_2 and India Ink were included, to compare their performance with the materials introduced in this study. The effect of TiO_2 concentration and its addition to some of the materials was included. This work introduced the use organometallic compounds for optical phantoms' production (due to previous characterizations that showed relevant absorbance behavior), and of laser-ablated nanoparticles in suspension in a liquid solution. The latter involves a YAG laser that focuses on a solid material, in this case, gold and zinc plates, and ablates nanoparticles from its surface. The nanoparticles stay in suspension in a solution with a surfactant to prevent particle agglomeration. These laser-ablated nanoparticles were used since materials in powder form (TiO_2 and organometallic compounds) resulted in some particle deposition in the sample holder (Fernandes, Pereira, et al., 2024).

RESULTS

Figure 1 presents a side-by-side comparison of the transmittance and reflectance spectra for each tissue, along with the corresponding spectra from the most similar phantoms.

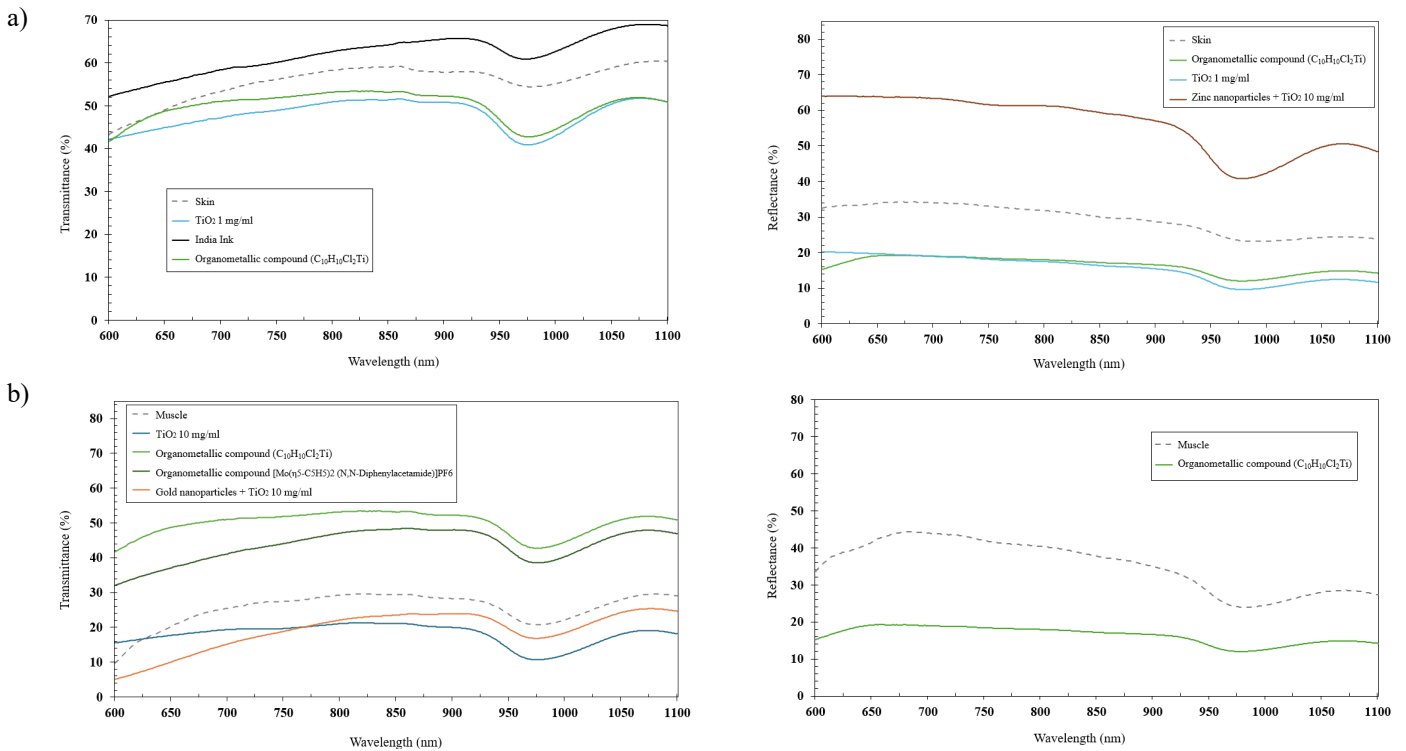

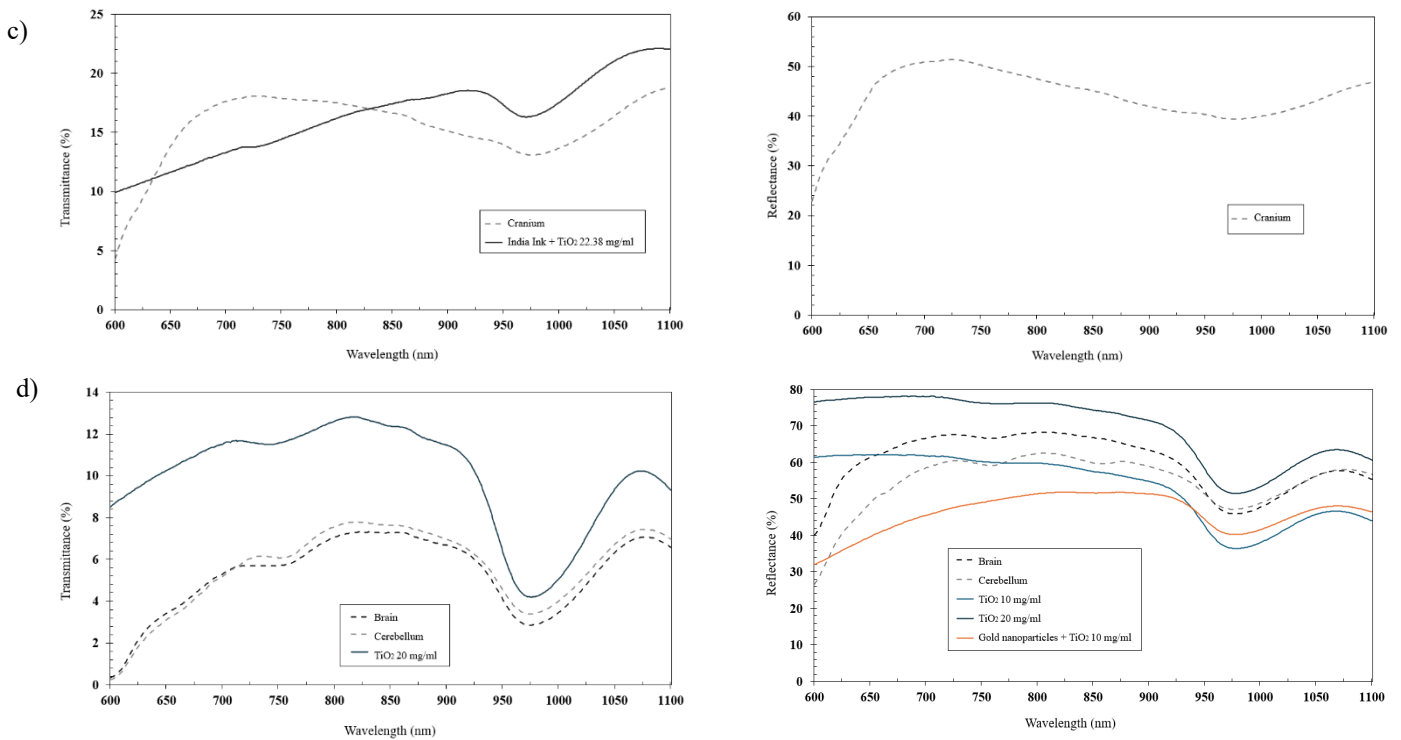

Figure 1 - Comparison between the transmittance and reflectance spectra (%) of different phantoms and their closeness to biological tissues: (a) skin; (b) muscle; (c) cranium; (d) brain and cerebellum.

CONCLUSIONS

The results show potential to mimic the optical properties of all the head tissues, apart from the cranium which did not have a similar reflectance spectrum, and the transmittance spectrum of India ink with TiO_2 is only similar after around 850 nm.

Although there is some overlap between the ability of a phantom to mimic the transmittance and reflectance of some tissues, a fine balance between the two must be explored in most cases. Future work must also include adjustments in component concentration to bring the curves closer in value.

ACKNOWLEDGMENTS

This work was supported by the project PTDC/EME-EME/1681/2021 – BrainStimMap, with DOI: 10.54499/PTDC/EME-EME/1681/2021, and by the FCT (Fundação para a Ciência e Tecnologia), under the reference projects UIDB/04436/2020 and UIDP/04436/2020. Susana Catarino thanks FCT for her contract funding provided through 2020.00215.CEECIND, with DOI: 10.54499/2020.00215.CEECIND/CP1600/CT0009.

REFERENCES

Fernandes, Filipa, Oliveira, Sofia, Monteiro, Francisca, et al. Devices used for photobiomodulation of the brain — a comprehensive and systematic review. *Journal of NeuroEngineering and Rehabilitation*. 2024. Vol. 21, no. 53, p. 1–29. DOI 10.1186/s12984-024-

01351-8.

Fernandes, Filipa, Pereira, Mário R. C., Soares, Delfim, et al. Development and optical characterisation of agarose-based phantoms mimicking biological tissues for studies of light penetration in the brain. *Biomaterials Science*. 2024. DOI 10.1039/d4bm01044b.

Hamblin, Michael R. Shining light on the head: Photobiomodulation for brain disorders. *BBA Clinical*. 2016. Vol. 6, p. 113–124. DOI 10.1016/j.bbacli.2016.09.002.

Salehpour, Farzad, Mahmoudi, Javad, Kamari, Farzin, et al. Brain Photobiomodulation Therapy: a Narrative Review. *Molecular Neurobiology*. 2018. Vol. 55, no. 8, p. 6601–6636. DOI 10.1007/s12035-017-0852-4.

Optimization of PDMS Curing in SLA Resin Molds: Techniques and Approaches

Andrews Souza^{2,4,6}, Conrado Ferrera³, Rui Lima^{2,5,6}, João Ribeiro^{1,7,8*}

¹Instituto Politécnico de Bragança, Campus de Santa Apolónia, 5300-253 Bragança, Portugal;

²MEtRICs, Mechanical Engineering Department, University of Minho, Campus de Azurém, 4800-058 Guimarães, Portugal;

³Depto. de Ingeniería Mecánica, Energética y de los Materiales and Instituto de Computación Científica Avanzada ICCAEx, Universidad de Extremadura, 06006 Badajoz, Spain

⁴CMEMS – UMinho, Universidade do Minho, 4800-058, Guimarães, Portugal; jgomes@dem.uminho.pt

⁵CEFT, Faculdade de Engenharia da Universidade do Porto (FEUP), Rua Roberto Frias, 4200-465 Porto, Portugal

⁶ALiCE, Faculty of Engineering, University of Porto, Porto, Portugal

⁷Centro de Investigação de Montanha (CIMO), Instituto Politécnico de Bragança, Campus de Santa Apolónia, 5300-253 Bragança, Portugal

⁸Laboratório Associado para a Sustentabilidade e Tecnologia em Regiões de Montanha (SusTEC), Instituto Politécnico de Bragança, Campus de Santa Apolónia, 5300-253 Bragança, Portugal

(***Email:** jribeiro@ipb.pt)

ABSTRACT

Cardiovascular diseases are the leading cause of death worldwide, with ischemic heart diseases and cerebrovascular diseases accounting for 85.6% of total cardiovascular deaths. Among these conditions, atherosclerosis, stenosis, and aneurysms stand out. In recent years, significant efforts have been invested in research to improve the diagnosis and treatment of these pathologies. In this pursuit, *in silico* and *in vitro* approaches have gained prominence, providing a better understanding of blood flow behavior in veins, facilitating the research of new devices, and contributing to prevention and diagnosis. However, these studies still require experimental validation.

One of the main challenges of *in vitro* experiments lies in the difficulty of manufacturing biomodels that accurately reproduce veins and allow for the visualization of blood flow. Recently, significant advances have been achieved using polydimethylsiloxane (PDMS). This material enables the development of transparent models, which are low-cost compared to glass and offer flexibility. Various techniques have been applied to these models, including Magnetic Resonance Imaging (MRI), Laser Doppler, Digital Image Correlation, Particle Tracking Velocimetry (PTV), and Particle Image Velocimetry (PIV), with the latter being the most widely used for validating numerical simulations.

Current techniques for manufacturing biomodels involve additive manufacturing and the use of PDMS. SLA and MSLA printers, which offer superior finish and quality compared to FDM printers, are becoming increasingly popular. However, a common challenge in using commercial SLA resins is the inhibition of PDMS curing, which hinders effective mold replication. To overcome these obstacles, various techniques have been employed, such as painting the molds, which creates a protective layer between the mold and the PDMS, as well as chemical and thermal treatments. Each of these approaches has its advantages and disadvantages. For example, painting can alter the dimensions of the mold, chemical treatment can weaken the structure, and thermal treatment can compromise dimensions if not performed at appropriate temperatures.

In this work, we will address the appropriate thermal treatment for two commercial resins that enable the development of molds for producing PDMS biomodels suitable for experimental testing. The correct choice of manufacturing and treatment methods is essential to ensure the accuracy and effectiveness of biomodels, allowing them to be used in various in vitro studies and contributing to advancements in cardiovascular disease research.

Keywords: Cardiovascular Biomodels; Polydimethylsiloxane (PDMS); Additive Manufacturing; Thermal Treatment.

MATERIALS AND METHODS

To manufacture the biomodels, the MSLA 3D printing technique was used with the Elegoo Mars 2 Pro printer (Elegoo Inc., Shenzhen, China) (Figure 1). The main technical features of this printer are:

- LCD resolution: 6.6-inch screen with 4K resolution (4098 x 2560 pixels), ensuring high precision in detail.
- Print platform dimensions: 143 mm (width) x 89.6 mm (depth) x 175 mm (height).
- Layer height: Adjustable, ranging from 0.01 mm (10 micron) to 0.2 mm (200 micron).
- XY accuracy: 35 micron (0.035 mm).

Two commercial resins were used:

1. Standard LCD, provided by Elegoo Inc.
2. PCWS1, produced by 3Dresyns (Barcelona, Spain).

The printing parameters used for each resin are described in Table 1.



Figure 1 – Msla printer.

The PDMS used was prepared with a mixing ratio of 10:1 (base to catalyst). After the mixing process, it was cured at room temperature for 48 hours to ensure complete crosslinking of the material.

Table 1 - 3D printing parameters for the resins used.

Resins	Base exposure time (s)	Exposure time (s)	Base layer
Standard LCD	6.813	35	8
PC WS1	17	120	7

However, for molds manufactured with commercial resins, the presence of substances such as tri-organophosphate and vinyl can inhibit the curing of PDMS, due to their high affinity for the platinum (Pt) catalyst. To overcome this problem, the following treatment process was implemented:

1. After printing, the resin molds were subjected to 2 hours of UV light post-treatment (Elegoo UV curing chamber, Shenzhen, China).
2. Then, 24 hours of heat treatment were carried out in an oven at 70°C, which eliminated the inhibitory substances and allowed efficient curing of the PDMS.

With this method, it was possible to guarantee suitable biomodels for in vitro experiments (Figure 2).

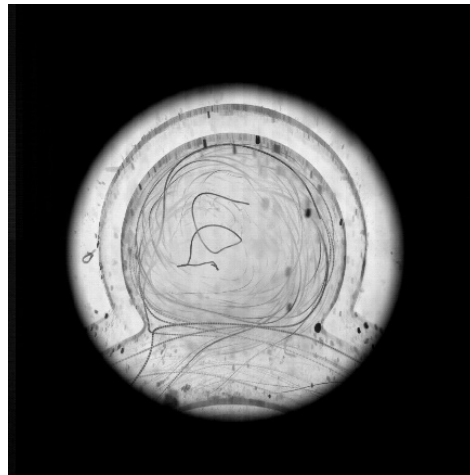
**Figure 2** - Experimental flow test.

CONCLUSION

The results of this study demonstrated that the combined use of UV and thermal treatment is an effective solution to overcome the difficulties related to the inhibition of PDMS curing in molds manufactured with commercial resins. The technique used allowed the production of high-precision and high-quality biomodels, essential for in vitro experiments in cardiovascular studies. Furthermore, the use of MSLA printers and appropriate resins provided an efficient and reproducible manufacturing process.

REFERENCES

- Carvalho, V., Maia, I., Souza, A., Ribeiro, J., Costa, P., Puga, H., Teixeira, S., & Lima, R. A. In vitro Biomodels in Stenotic Arteries to Perform Blood Analogues Flow Visualizations and Measurements: A Review. *The Open Biomedical Engineering Journal*, 2021, 14(1), pp. 87–102. <https://doi.org/10.2174/1874120702014010087>
- Ribeiro, J.E., Lopes, H., Martins, P. A hybrid method to characterise the mechanical behaviour of biological hyper-elastic tissues, *Computer Methods in Biomechanics and Biomedical Engineering: Imaging & Visualization*, 2017, 5(2), pp. 157-164. <https://doi.org/10.1080/21681163.2015.1034295>
- Saqr, K. M., Rashad, S., Tupin, S., Niizuma, K., Hassan, T., Tominaga, T., & Ohta, M. What does computational fluid dynamics tell us about intracranial aneurysms? A meta-analysis and critical review. *Journal of Cerebral Blood Flow and Metabolism*, 2019, 40(5), 1021–1039. <https://doi.org/10.1177/0271678X19854640>
- Souza, M.S., Souza, A., Carvalho, V., Senhorinha, T., Fernandes, C., Lima, R., Ribeiro, J. Fluid Flow and Structural Numerical Analysis of a Cerebral Aneurysm Model. *Fluids*, 2022, 7(3), 100. <https://doi.org/10.3390/fluids7030100>
- Victor, A., Ribeiro, J., & Araújo, F. F. (2019). Study of PDMS characterization and its applications in biomedicine: A review. *Journal of Mechanical Engineering and Biomechanics*, 2019, 4(1), pp. 1-9. <https://doi.org/10.24243/JMEB/4.1.163>

Valorisation of Olive Mill Wastewaters for Industrial Applications

I. S. Afonso^{1,2,3,4}, A. Ribeiro^{2,3,5}, J. Amaral^{2,3,5}, P. Sousa⁴, R. A. Lima^{1,6,7}, J. E. Ribeiro^{2,3,5*}

¹MEtRICs, Mechanical Engineering Department, University of Minho, Campus de Azurém, 4800-058 Guimarães, Portugal

²Centro de Investigação de Montanha (CIMO), Instituto Politécnico de Bragança, Campus de Santa Apolónia, 5300-253 Bragança, Portugal

³Laboratório Associado para a Sustentabilidade e Tecnologia em Regiões de Montanha (SusTEC), Instituto Politécnico de Bragança, Campus de Santa Apolónia, 5300-253 Bragança, Portugal

⁴INL, International Iberian Nanotechnology Laboratory, Avenida Mestre José Veiga, 4715-330, Braga, Portugal

⁵Instituto Politécnico de Bragança, Campus de Santa Apolónia, 5300-253 Bragança, Portugal

⁶CEFT, Faculdade de Engenharia da Universidade do Porto (FEUP), Rua Roberto Frias, 4200-465 Porto, Portugal

⁷ALiCE, Faculty of Engineering, University of Porto, 4200-465 Porto, Portugal

(*)**Email:** jribeiro@ipb.pt

ABSTRACT

Olive mill wastewaters (OMWW) are a byproduct of the olive oil production process, posing significant environmental challenges due to their high organic load and chemical complexity. This research aims to explore the potential industrial application of OMWW as a cutting fluid in metalworking processes, thus transforming a problematic waste into a valuable resource. To achieve this, a comprehensive mechanical, chemical, and biological characterization of OMWW was conducted, alongside tribological tests to evaluate its performance in comparison to conventional industrial cutting fluids. Preliminary results indicate that OMWW exhibits competitive tribological properties, suggesting its viability as an eco-friendly alternative. This study contributes to both the valorisation of agro-industrial waste and the development of sustainable manufacturing practices.

Keywords: Olive Mill Wastewaters (OMWW); Cutting Fluid; Tribological Properties; Sustainable Manufacturing.

INTRODUCTION

The growing interest in sustainable industrial practices has led to the exploration of various waste products for new applications. One such byproduct is olive mill wastewater (OMWW), which poses environmental challenges due to its high organic load and complex composition (Afonso, 2022). However, recent studies suggest OMWW could be repurposed as a cutting fluid in metalworking processes (Afonso et al., 2022). Transforming this waste into a valuable industrial resource can reduce environmental impact and contribute to circular economy principles.

To evaluate OMWW's potential as a cutting fluid, it is essential to assess its mechanical, chemical, and biological properties, as these factors directly influence its performance in industrial applications. Various studies have demonstrated the importance of fluid properties in the efficiency of machining processes, including tribological performance, cooling capacity, and biocompatibility (Afonso, Nobrega, et al., 2023). A comprehensive understanding of OMWW's behaviour compared to conventional cutting fluids is critical to establishing it as a viable

alternative.

In this study, tribological tests were conducted to compare OMWW's performance against standard cutting fluids (Afonso et al., 2022). These tests included friction coefficient measurements and wear analysis, both of which are critical indicators of a cutting fluid's effectiveness. Additionally, chemical analyses were performed to ensure OMWW's compatibility with industrial machinery, as certain compounds could potentially cause corrosion or other undesirable effects (Afonso, Duarte, et al., 2023). The results of these tests are promising, indicating that OMWW may be an eco-friendly alternative to conventional fluids.

RESULTS

The material used for testing was a stainless-steel plate subjected to cutting operations using both OMWW and conventional cutting fluids. The OMWW was characterized by its viscosity, antioxidant content, and tribological performance, which were compared against a standard industrial cutting fluid. Two separate tribological tests were conducted: one to evaluate the coefficient of friction and another to measure wear on the cutting tool.

The friction coefficient results correspond to the alumina/stainless steel 316L sliding pair under various lubrication conditions. A total of seven tribological tests were conducted: one under dry (unlubricated) conditions, one with Balis MAFCOOL 51 cutting oil, two with Vegetable Oil 1, two with Vegetable Oil 2, and one with distilled water.

Each sliding test was carried out for 7200 s and the friction coefficient was continuously recorded. Figure 1 illustrates the experimental setup used in the tribological tests, while Figure 2 shows the comparative wear results between OMWW and conventional fluids.

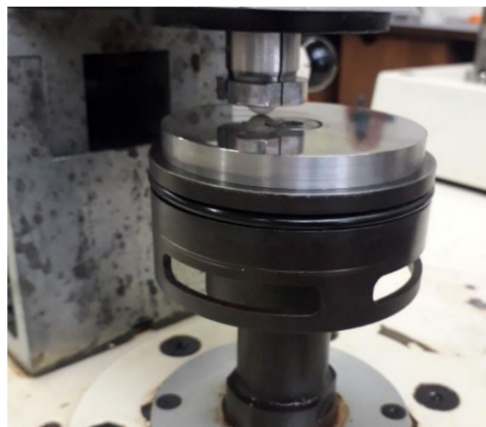

Figure 1 - Experimental setup for tribological testing of OMWW.

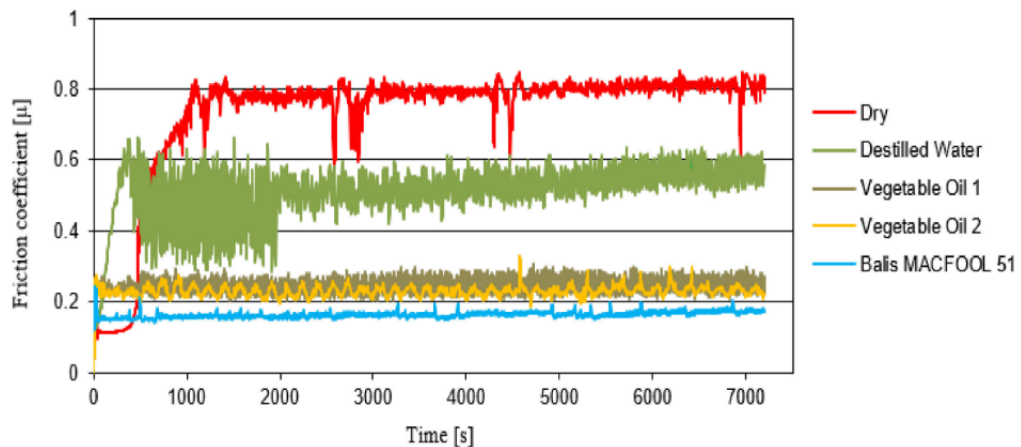

Figure 2 - The comparative wear analysis or friction coefficient results between OMWW and conventional cutting fluids.

As shown in Figure 2, the dry sliding condition yielded the highest friction coefficient (0.79), as anticipated, while the sliding test with distilled water resulted in an average steady-state friction coefficient of 0.54. Both Vegetable Oil 1 and Vegetable Oil 2 exhibited similar friction behavior, with average friction coefficients of 0.26 and 0.25, respectively. The industrial cutting fluid, Balis MAFCOOL 51, recorded the lowest average friction coefficient of 0.16, which was an expected outcome. In terms of friction coefficient stability during sliding, the vegetable oils and the industrial cutting fluid demonstrated smoother friction coefficient evolution curves compared to the tests conducted with distilled water or under dry conditions.

CONCLUSIONS

In the tribological tests, the two vegetable oils exhibited minimal difference in friction coefficient values (0.26 and 0.25). While these values were higher than those obtained with the industrial cutting fluid, Balis MAFCOOL 51 (0.16), they remain satisfactory, suggesting that vegetable oils are a viable alternative to industrial cutting fluids. Additionally, no measurable wear was observed on the alumina ball during sliding tests with vegetable oils, whereas wear was detected with the cutting fluid. This further supports the potential of vegetable oils as effective cutting fluids.

The results of this study are promising and suggest that olive mill wastewater has the potential to be used as a sustainable cutting fluid. The tribological performance of OMWW, especially in reducing friction and wear, aligns closely with that of conventional fluids. Ongoing research aims to further optimize the chemical composition of OMWW for enhanced industrial applications, with a focus on improving its performance and minimizing any potential negative environmental impacts.

ACKNOWLEDGMENTS

This research was also partially funded by EXPL2021CIMO_01. Inês S. Afonso was supported by the doctoral grant 2024.05919.BDANA, financed by the Portuguese Foundation for Science and Technology (FCT). The research team would also like to thank Lagar de Lamalonga and Lagar das Arcas for kindly providing the OMWW samples.

REFERENCES

Afonso, I., Ribeiro, A., Amaral, J., Rodrigues, N., Gomes, J., Lima, R., Ribeiro J. Analysis of a Vegetable Oil Performance in a Milling Process by MQL Lubrication', *Micromachines*, 2022 13(8), pp. 1–20. <https://doi.org/10.3390/mi13081254>.

Afonso, Inês S. et al. Conventional and Recent Advances of Vegetable Oils as Metalworking Fluids (MWFs): A Review. *Lubricants*, 2023, 11(4), p. 160. Available at: <https://doi.org/https://doi.org/10.3390/lubricants11040160>

Afonso, Inês S et al. Didactic Analysis of Olive Mill Wastewaters Antimicrobial Activity, in F.J. García-Peñalvo and A. García-Holgado (eds) *Proceedings TEEM 2022: Tenth International Conference on Technological Ecosystems for Enhancing Multiculturality*. 2023 Singapore: Springer Nature Singapore, pp. 457–465. Available at: https://doi.org/10.1007/978-981-99-0942-1_47

Afonso, Inês S. et al. Green synthesis of nanoparticles from olive oil waste for environmental and health applications: A review. *Journal of Environmental Chemical Engineering*, 2024, 12(5), p. 114022. Available at: <https://doi.org/https://doi.org/10.1016/j.jece.2024.114022>

Noblega, Glauco et al. Didactic Experimental Investigation of Green Nanofluids: Assessment of Wettability, Viscosity and Thermal Conductivity, *ASME 2024 7th International Conference on Micro/Nanoscale Heat and Mass Transfer*, 2024, Nottingham, United Kingdom. Available at: <https://doi.org/10.1115/MNHMT2024-132927>

Effects of extensive green roofs on rainwater drainage from a metalworking industry building

J. Rodrigues^{1,2}, H. Mazzer², A. Gerales³, F. Silva^{1,4,5*}

¹ESTiG, Instituto Politécnico de Bragança, 5300-253, Bragança, Portugal

²Campus Campo Mourão, Universidade Tecnológica Federal do Paraná, Campo Mourão 87301-899, PR, Brasil

³CIMO, LA SusTEC, Instituto Politécnico de Bragança, Campus de Santa Apolónia, 5300- 253 Bragança, Portugal

⁴GICoS, Instituto Politécnico de Bragança, 5300-253, Bragança, Portugal

⁵GeoBioTec, Universidade da Beira Interior, 6201-001, Covilhã, Portugal

(*)**Email:** flora@ipb.pt

ABSTRACT

This study examines how extensive green roofs impact the sizing of the rainwater drainage system for a metalworking building in northeastern Portugal. If the roof, measuring approximately 4,700 m², is constructed of sheet metal, the calculated flow rate that must be drained is 5,860.51 L/min. In contrast, if the roof is green and extensive, the calculated flow rate drops to 3,255.84 L/min. This represents a 44.44% retention of rainwater, which necessitates changes in the components of the drainage system. Additionally, the green roof delays the release of unretained water into the urban drainage system, thereby contributing to sustainable urban drainage and helping to mitigate urban flooding.

Keywords: Rainwater drainage systems; Green roofs; Portuguese regulations; Sustainability; Urban flooding mitigation.

INTRODUCTION

Vegetation on roofs is critical in helping cities adapt to climate change and aligns with sustainability principles. It promotes water retention, reduces surface runoff, and improves water quality (Calheiros & Pereira, 2023). As noted by Pineda-Martos *et al.* (2024), the importance of Nature-Based Solutions (NBS) is closely related to the concept of a circular economy, which advocates for regenerative design solutions to minimize resource input, energy consumption, and emissions. Moreover, strategies prioritizing resource conservation, greener environments, and water-sensitive systems can enhance resilience by providing essential ecosystem functions, such as stormwater management and mitigating the urban heat island effect. Green roofs are an example of NBS that can be integrated with other tools to promote a circular water economy in urban environments, reducing pressure on watercourses (Calheiros *et al.*, 2022; Pearlmutter *et al.*, 2020). These roofs can be installed on new and existing buildings, offering various benefits for users and the environment at individual, urban, and ecological scales. They have a high capacity for rainwater retention and delay excess water flow (not retained in the green roof system) into the urban drainage system (ANCV, 2019). Green roofs are classified based on the substrate depth as follows: extensive (<15 cm), semi-intensive (>15 cm and <25 cm), or intensive (>25 cm) (Calheiros *et al.*, 2022; Calheiros & Stefanakis, 2021; ANCV, 2019). Extensive green roofs are more commonly implemented due to their lighter weight, lower cost, and reduced maintenance needs compared to other types (Calheiros & Stefanakis, 2021). Incorporating NBS into building and urban systems is essential for optimizing construction practices and fulfilling sustainability requirements. This study aims to analyze how extensive green roofs impact the sizing of rainwater

drainage networks in a metalworking industry building compared to conventional roofs, following Portuguese regulations (Rodrigues, 2024).

RESULTS

The rainwater drainage system for the industrial building in Bragança has been designed in accordance with Decree 23/95, 23 August, along with the guidelines outlined in Pedroso (2016). The system demonstrates several differences when comparing conventional sheet metal roofing (CR) to extensive green roofing (GR):

- Roof area: 4,700 m²;
- Runoff coefficient: 0.9 for CR and 0.5 for GR;
- Rainfall intensity: 1.4 L/min·m²;
- Calculated flow rate using the rational method ($Q = CIA$): 5,860.51 L/min for CR and 3,255.84 L/min for GR;
- Rainwater retention by GR: 44.44%;
- Reduction in the size of rectangular gutters;
- Reduction in the diameter of downpipes;
- Reduction in the diameter of building collectors: the last collector measures 315 mm for CR and 250 mm for GR.

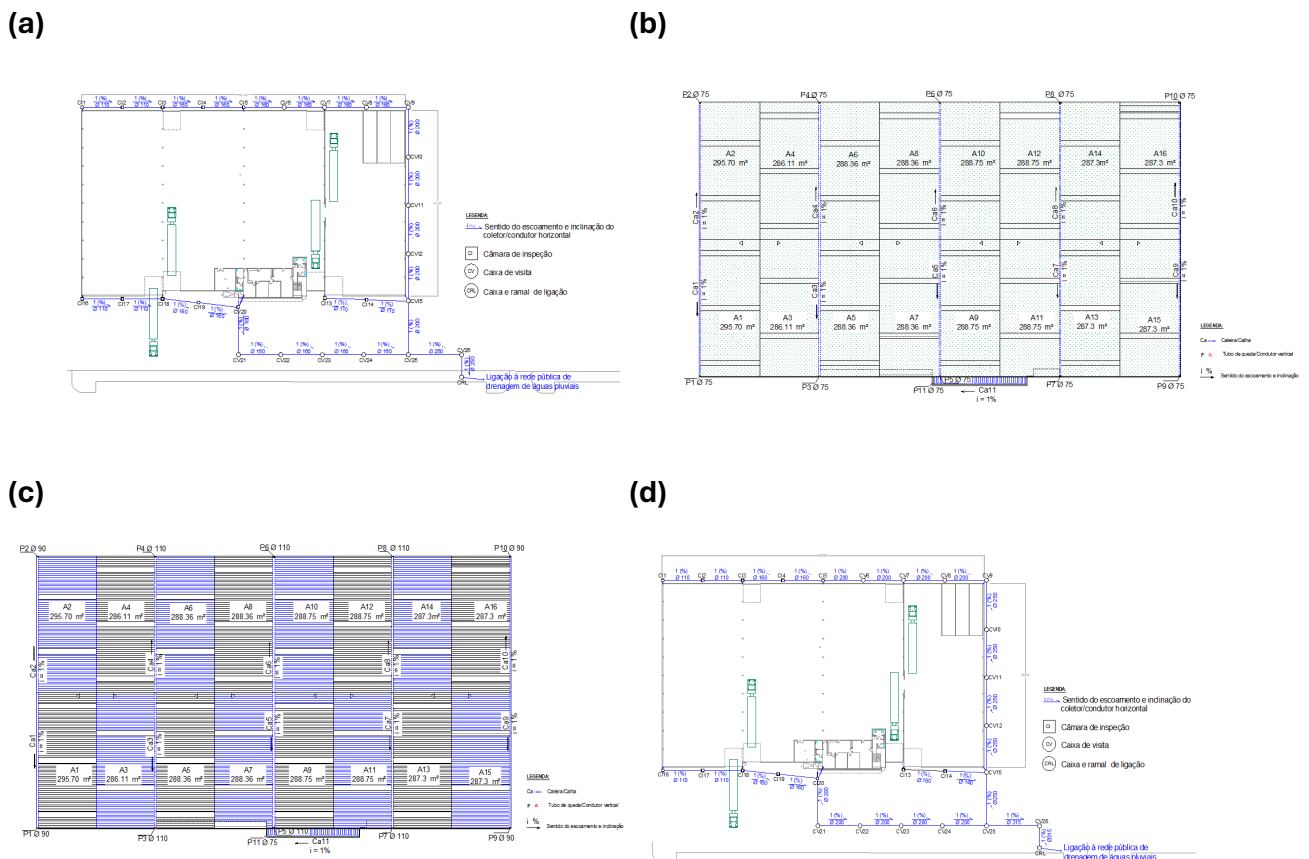

Figure 1 - Rainwater drainage network: extract of the roof plan (a) and first floor (b), conventional roof; extract of the roof plan (c) and first floor (d), green roof.

While this case study focuses on the scale of the building, the potential impact of this NBS on the city could be significant. According to Brandão *et al.* (2017), if 75% of the flat roof area in the municipality of Lisbon were converted to green roofs, approximately 166500 to 224000 m³ of water could be retained during extreme rainfall events. This would help relieve pressure on drainage systems and prevent flooding.

CONCLUSIONS

While conventional roofs allow rainwater to run off quickly, which can increase flooding, green roofs help absorb this water, slowing runoff and promoting evapotranspiration. This process enhances the effectiveness of stormwater management in buildings and urban areas.

Green roofs must integrate with the built environment, incorporating existing gray infrastructure to create circular, resilient, and resourceful cities. To enhance their effectiveness, new buildings should include these systems, along with retrofitting existing structures (Calheiros & Pereira, 2023).

ACKNOWLEDGMENTS

The authors are grateful to the Foundation for Science and Technology (FCT, Portugal) for financial support by national funds FCT/MCTES (PIDDAC) to CIMO (UIDB/00690/2020 and UIDP/00690/2020), SusTEC (LA/P/0007/2020), and GeoBioTec (UIDB/04035/2020 and UIDP/04035/2020).

REFERENCES

- ANCV. *Guia técnico para projeto, construção e manutenção de coberturas verdes*. 1.^a ed., Porto: Associação Nacional de Coberturas Verdes, 2019.
- Brandão, C., do Rosário Cameira, M., Valente, F., Cruz de Carvalho, R. & Paço, T.A. (2017). Wet Season Hydrological Performance of Green Roofs Using Native Species under Mediterranean Climate. *Ecological Engineering*, Vol.102, pp.596-611. <https://doi.org/10.1016/j.ecoleng.2017.02.025>
- Calheiros, C.S.C. & Pereira, S.I.A. (2023). Resilience of green roofs to climate change. In *Adapting the Built Environment for Climate Change*, pp. 273-296. <https://doi.org/10.1016/C2021-0-02571-2>
- Calheiros, C.S.C. & Stefanakis, A.I. (2021). Green Roofs Towards Circular and Resilient Cities, *Circular Economy and Sustainability*, Vol.1, pp.395-411. <https://doi.org/10.1007/s43615-021-00033-0>
- Calheiros, C.S.C., Castiglione, B. & Palha, P. (2022). Chapter 14 - Nature-Based Solutions for Socially and Environmentally Responsible New Cities: The Contribution of Green Roofs. In *Circular Economy and Sustainability*, Vol.2, pp. 235-255. <https://doi.org/10.1016/B978-0-12-821664-4.00015-7>
- Decreto Regulamentar n.º 23/95, de 23 de agosto. Regulamento Geral dos Sistemas Públicos e Prediais de Distribuição de Água e de Drenagem de Águas Residuais.

Pearlmutter, D., Theochari, D., Nehls, T., Pinho, P., Piro, P., Korolova, A., Papaefthimiou, S., Mateo, M.C.G., Calheiros, C., Zluwa, I., *et al.* (2020). Enhancing the Circular Economy with Nature-Based Solutions in the Built Urban Environment: Green Building Materials, Systems and Sites. *Blue-Green Systems.*, Vol.2, pp.46-72. <https://doi.org/10.2166/bgs.2019.928>

Pedroso, V. *Manual dos Sistemas Prediais de Distribuição e Drenagem de Águas*. 3.^a ed. Lisboa: Laboratório Nacional de Engenharia Civil, 2016.

Pineda-Martos, R. *et al.* (2024). Implementing Nature-Based Solutions for a Circular Urban Built Environment. In: Bragança, L., Cvetkovska, M., Askar, R., Ungureanu, V. (eds) *Creating a Roadmap Towards Circularity in the Built Environment*. Springer Tracts in Civil Engineering. Springer, Cham. https://doi.org/10.1007/978-3-031-45980-1_28

Rodrigues, J. (2024). Influência de Soluções baseadas na Natureza no dimensionamento de sistemas prediais de drenagem de águas pluviais: Casos de estudo. Dissertação de mestrado, Instituto Politécnico de Bragança.

Extraction of natural fibers for the manufacture of 3D filaments by FDM material extrusion

F Y M Stein¹, J Rocha¹, J Santos¹, J Ribeiro¹, L Deusdado¹, C Rocha¹

¹Instituto Politécnico de Bragança, 5300-253, Bragança, Portugal

(*)Email: felipe.stein@ipb.pt

ABSTRACT

The study aimed to extract hemp fibers for the NaturFab project, in order to mechanically strengthen PLA in filaments for 3D printing. In order to find the best extraction method, several chemical treatments were carried out to separate the fibers from the plant, using solutions of 2 g/l of sodium hydroxide (NaOH) + 2 g/l of sodium carbonate (NaCO₃) and another solution of 6% NaOH, both at 80 °C. After obtaining the first fiber sample, tensile tests were carried out to compare the strength of the hemp fibers with those of commercial flax. Hemp showed inferior performance compared to flax fibers, with a more fragile behavior after treatment with 6% NaOH. However, a solution of NaOH and NaCO₃ with polyglycolic detergent facilitated extraction and improved fiber strength, but further tests should be carried out to verify its effectiveness.

Keywords: Hemp Fiber Extraction; Chemical Treatments; PLA Reinforcement; Tensile Strength.

CONTEXT

The following study was carried out with the aim of obtaining hemp fibers for the NaturFab project, which seeks to incorporate them into 3D printing filaments to increase the mechanical strength of PLA, as observed in the study carried out by (Deb & Jafferson, 2021).

In this work, different chemical treatments were carried out to obtain the fibers, seeking to identify the best way to remove the fibers from the hemp plants.

MATERIAL & METHODS

This topic discusses the methods used to obtain natural fibers for incorporation into 3D printing filaments.

Obtaining the hemp for the experiments

In order to obtain the hemp fibers, the plants that were grown as shown in figure 1 were harvested and left to dry in the environment for 36 days in the case of Date 1 and 30 days in the case of Date 4, as shown in table 1. The variations Date 1 to 4 refer to the planting dates of the samples, with Date 1 being the oldest and Date 4 the most recent.



Figure 1 - IPB hemp plantation.

Table 1 - Planting, harvesting and experiment dates.

Variation	Planting	Harvesting	Experiment
Date 1	21/may	13/aug	18/sep
Date 2	03/jun	13/aug	-
Date 3	18/jun	19/aug	-
Date 4	02/jul	19/aug	18/sep

Chemical treatments applied to hemp

To obtain hemp fiber, two different chemical treatments were applied. In the first, a 6% solution of sodium hydroxide (NaOH) was used, which was heated to 80 °C; after reaching this temperature, the plant was immersed and left for half an hour to assess the progress of the decomposition of lignin and hemicellulose that causes the fibers to loosen, similar to the processes seen in (Deb & Jafferson, 2021), (Paulo, Santos, Rocha, Lima, & Ribeiro, 2023) In the second treatment, the samples were immersed in a solution of 2g/l of sodium carbonate (NaCO₃) and 2g/l of sodium hydroxide (NaOH) also heated to 80 °C (Figure 2) for half an hour, similar to that carried out in (Mariz, 2023), in order to compare progress.

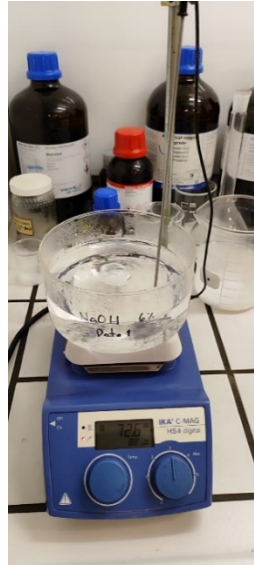

Figure 2 - Equipment used to heat the solution.

After the chemical treatments, all the samples were left to dry in a hotte with the ventilation on for a period of 24 hours, as shown in Figure 3.



Figure 3 - Samples drying in the chapel.

The samples were then analyzed to see which had the most effective result in terms of obtaining fibers. Once the best sample had been identified, the experiment was repeated with the same solution at 80 °C, leaving it immersed for 24 hours and drying it before removing the fibers.

Mechanical tests applied to the fibers

After obtaining the fiber, a tensile test was carried out on samples of hemp fiber obtained through chemical treatment and flax fiber obtained commercially. The test parameters were similar to those used in the study in (Ribeiro, Bueno, Martin, & Rocha, 2023) with a test speed of 3 mm/min.

To attach the fibers to the jaws of the test machine, cards were cut out on which the fibers were glued, as shown in Figures 4 and 5, thus preventing the fibers from breaking or slipping when they were attached. After placing the card with the fiber in the machine's jaws, the sides of the card were cut so that the polymer would not interfere with the test results.

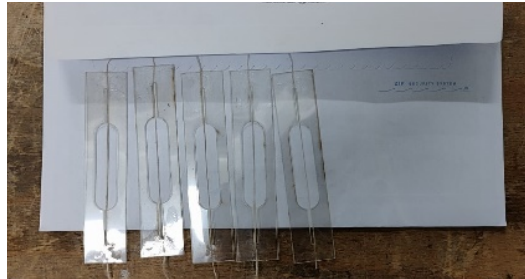

Figure 4 - Prepared flax samples.

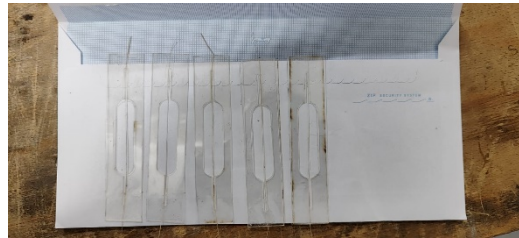

Figure 5 - Prepared hemp samples.

RESULTS AND DISCUSSIONS

This section will present the results of the experiments carried out to obtain the natural fibers, as well as the tests carried out to compare them with commercially obtained flax.

Obtaining the hemp fibers

The Data 1 and Data 4 hemp samples were placed in solutions of 6% sodium hydroxide (NaOH) and a mixture of 2g/l sodium carbonate (NaCO₃) and 2g/l sodium hydroxide (NaOH). After a period of 30 minutes at 80 °C, the samples were removed and the results shown in Figures 6, 7, 8 and 9 were obtained.

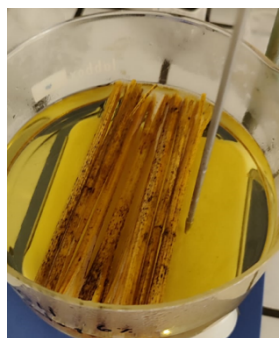

Figure 6 - Hemp Date 1 6% NaOH 30 minutes.

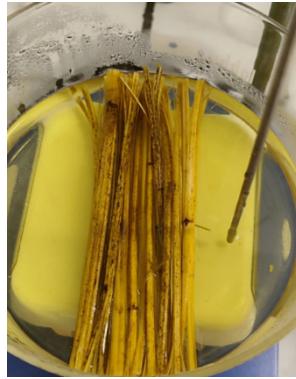

Figure 7 - Hemp Date 1 2 g/l NaOH + 2 g/l NaCO₃ 30 minutes.



Figure 8 - Hemp Date 4 6% NaOH 30 minutes.

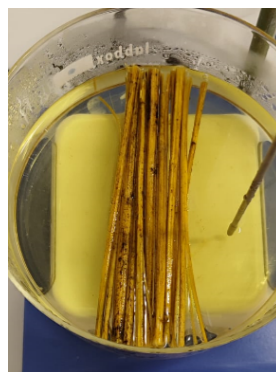

Figure 9 - Hemp Date 4 2 g/l NaOH + 2 g/l NaCO₃ 30 minutes.

All samples were subsequently dried under controlled airflow conditions for 24 hours. Following this drying phase, it was observed that the sample treated with sodium hydroxide, labeled as Data 1, demonstrated the highest fiber detachment potential. With the identification of the most effective sample and solution, an additional experiment was conducted at 80°C for 24 hours. This procedure yielded a result that successfully facilitated fiber extraction, as illustrated in Figure 10.



Figure 10 - First fiber sample taken from Date 1.

Following fiber extraction, hemp fiber samples and commercially sourced flax fiber samples were prepared and subjected to tensile strength testing. The results indicated that the hemp fibers exhibited significantly lower tensile strength compared to the flax fibers, as illustrated in Figure 10.

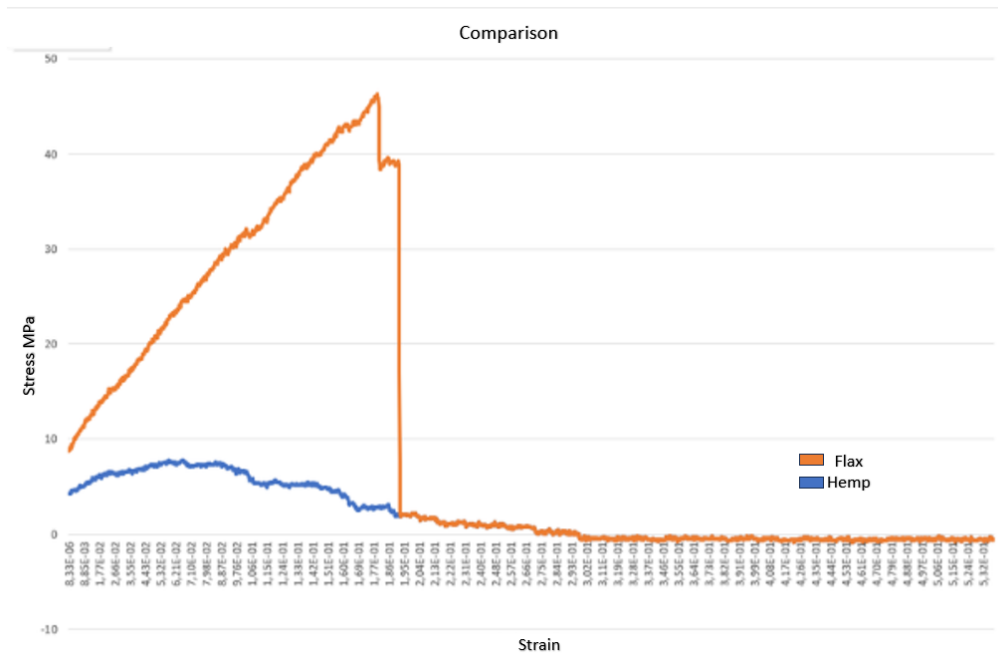

Figure 10 – Comparison of flax and hemp.

After the initial tests, a new experiment was conducted in which the plant materials were immersed for 5 hours in a solution containing 2 g/L NaOH, 2 g/L Na₂CO₃, and 0.5 mL/L polyglycolic ether detergent at 80°C. In this modified experiment, the fibers separated more readily compared to previous trials and exhibited a less brittle texture.

CONCLUSIONS

The initial experiments did not yield fibers with satisfactory performance characteristics when using the solutions applied. Specifically, the 6% sodium hydroxide solution weakened the hemp fibers. Additionally, because the plants were already dry, the hydration process was slower, and the lignin adhered more firmly to the fibers after drying, complicating the fiber extraction process.

The solution containing 2 g/L NaOH, 2 g/L Na₂CO₃, and 0.5 mL/L polyglycolic ether detergent was more effective in facilitating fiber extraction. With this solution, fibers were obtained in a shorter time and displayed a less brittle texture. However, to verify the mechanical robustness of these fibers, further comparative tensile strength tests are required.

Future studies could benefit from exploring alternative methods for hemp fiber extraction, including both mechanical and biological approaches. Such approaches, already investigated by other researchers for extracting various natural fibers, may provide improved fiber quality and performance characteristics.

ACKNOWLEDGMENTS

This work was supported by the project Interreg 0049_NaturFab_2_E.

REFERENCES

- Deb, D., Jafferson, J. Natural fibers reinforced FDM 3D printing filaments. *Materials Today: Proceedings*, 2021, 46(2). <https://doi.org/10.1016/j.matpr.2021.02.397>
- Mariz, J.M. Estudo de Fibras de Base Natural para Aplicação na Indústria Têxtil. Master's Thesis, 2023, Universidade do Minho: Guimarães.
- Paulo, A., Santos, J., Rocha, J. d., Lima, R., Ribeiro, J. Mechanical Properties of PLA Specimens Obtained by Additive Manufacturing Process Reinforced with Flax Fibers. *Journal of Composites Science*, 2023, 7(1), 27. <https://doi.org/10.3390/jcs7010027>
- Ribeiro, J., Bueno, G., Martin, M. R., Rocha, J. Experimental Study on Mechanical Properties of Hemp Fibers Influenced by Various Parameters. *Sustainability*, 2023, 15(12), 9610. <https://doi.org/10.3390/su15129610>
- Ribeiro, J.E., Rocha, J. Queijo, L.C. The influence of manufacturing factors in the short-fiber non-woven chestnut hedgehog spine-reinforced polyester composite performance. *Journal of Natural Fibers*, 2021, 18(9), pp. 1307-1319. <https://doi.org/10.1080/15440478.2019.1691109>

Strategies for Modifying PDMS Wettability and Potential Applications

Lucas B. Neves^{1,2}, Inês S. Afonso^{3,4}, Glaucio Nobrega^{3,4}, Luiz G. Barbosa², Rui A. Lima^{3,5,6} and João E. Ribeiro^{1,4,*}

¹Instituto Politécnico de Bragança, Campus Santa Apolónia, 5300-253 Bragança, Portugal; neves.lucas17@gmail.com

²Instituto Federal de Educação, Ciência e Tecnologia do Rio Grande do Sul (IFRS), Campus Erechim, Erechim, RS, Brazil; luiz.barbosa@erechim.ifrs.edu.br

³MEtRICs, Mechanical Engineering Department, University of Minho, Campus de Azurém, 4800-058 Guimarães, Portugal; inesafonso@ipb.pt (I.S.A.); glaucotvn@hotmail.com (G.N.); rl@dem.uminho.pt (R.A.L.)

⁴CIMO, Instituto Politécnico de Bragança, Campus S. Apolónia, 5300-253 Bragança, Portugal

⁵CEFT— Transport Phenomena Research Center, Faculty of Engineering, University of Porto, Rua Dr. Roberto Frias, 4200-465 Porto, Portugal

⁶Associate Laboratory in Chemical Engineering (ALiCE), Faculty of Engineering, University of Porto, 4200-465 Porto, Portugal

*Correspondence: jribeiro@ipb.pt

(*)**Email:** neves.lucas17@gmail.com

ABSTRACT

Polydimethylsiloxane (PDMS) has garnered significant attention across various fields due to its excellent properties, but its inherent hydrophobicity poses challenges for applications that require controlled wettability. This review provides an overview of key traditional strategies for modifying PDMS surface wettability, focusing on methods such as oxygen plasma treatment, surfactant addition, UV-ozone treatment, and nanomaterial incorporation. These methods are commonly chosen due to their availability, simplicity, and lower cost. Oxygen plasma treatment is widely used to enhance PDMS hydrophilicity by introducing polar functional groups. Surfactant addition is a versatile approach for altering surface properties, influenced by the type and concentration of surfactant. UV-ozone treatment increases surface energy by inducing oxidation, while nanomaterial incorporation, including nanoparticles and nanotubes, offers a promising route for adjustable wettability through controlled interactions. This review discusses recent advancements in each technique, their mechanisms, advantages, and limitations, as well as future trends in PDMS surface modification for applications like microfluidics and biomedical devices.

Keywords: Polydimethylsiloxane (PDMS); Surface Wettability; Hydrophilicity Modification; Nanomaterial Incorporation.

INTRODUCTION

Polydimethylsiloxane (PDMS) is widely recognized and used in various micro and nano applications due to its excellent properties, such as biocompatibility, optical transparency and low cost. However, its natural hydrophobicity presents significant challenges in applications requiring controlled wettability. This paper reviews the main approaches commonly used to

modify the wettability of PDMS surfaces, focusing on methods such as oxygen plasma treatment, the addition of surfactants, UV-Ozone treatment and the incorporation of nanomaterials, as shown in Figure 5 (Neves et al., 2024).

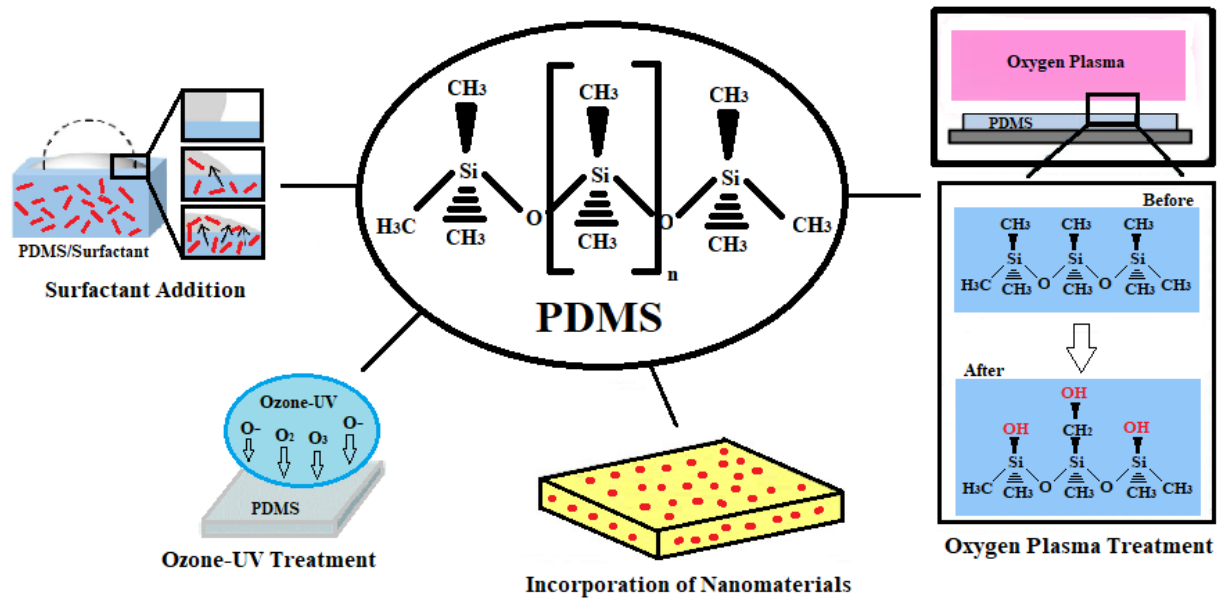

Figure 5 - Methods of altering wettability in PDMS.

Oxygen plasma treatment

Oxygen plasma treatment is widely used to improve the hydrophilicity of PDMS, as it introduces polar functional groups through oxidation reactions. Although effective, the effect is not permanent, with the PDMS surface recovering its hydrophobicity over time. The oxygen is ionized to form ions and free electrons, which interact with the PDMS surface, breaking bonds and introducing oxygen-containing functional groups. The oxygen plasma chamber is a controlled environment where the gas is ionized and modifies the PDMS surface, causing chemical and physical changes. This method has applications including microfluidic devices, adhesives, sealants, electronic circuits, biomedical implants, packaging coatings and chemical sensors. Exposure to plasma results in the formation of an oxide layer on the surface, increasing hydrophilicity. Hydrophobicity tends to return over time due to the migration of oligomers and reorientation of polar groups. Studies show that storage in deionized water can prolong hydrophilicity.

UV-Ozone treatment

UV-Ozone treatment uses UV light and ozone to increase the surface energy of PDMS, inducing oxidation and generating hydrophilic functional groups. Although comparable to oxygen plasma treatment, the rate of modification is slower. The combination of UV light and ozone is effective in modifying the wettability of PDMS, with results similar to oxygen plasma treatment. UV-Ozone treatment oxidizes the surface chains of PDMS without causing cracking, as can occur with oxygen plasma treatment. Applications include microfluidic devices and surface modification to

improve adhesion and functionality. Hydrophobic recovery is observed in both treatments, but is slower in the UV-Ozone treatment, due to the greater thickness of the modified layer. The curing time of PDMS influences the speed of surface hydrophilization after UV-ozone treatment.

Addition of Surfactants

The addition of surfactants is a flexible approach to altering the wettability of PDMS. Ionic and non-ionic surfactants can be used to make the PDMS surface hydrophilic. Surfactants have both hydrophobic and hydrophilic portions, facilitating the dispersion of aqueous solutions on originally hydrophobic surfaces. Modification methods include mass mixing and immersion in solutions containing surfactants. Applications include microfluidic devices, antibiofouling coatings and biomedical devices. The addition of surfactants can significantly reduce the water contact angle (WCA), making PDMS hydrophilic. The stability of the hydrophilicity is a challenge, with some surfactants completely reversing the WCA after immersion in water.

Incorporation of nanomaterials

The incorporation of nanomaterials into PDMS offers a promising approach to modifying wettability, allowing surface properties to be adjusted through interfacial interactions and controlled dispersion. Nanomaterials, such as nanoparticles and nanotubes, improve wettability and increase the surface energy of PDMS. Applications include oil-water separation, antibacterial activity and flame-retardant properties. The incorporation of nanomaterials increases the roughness of the PDMS surface, resulting in superhydrophobicity. The durability of the modifications caused by nanomaterials is widely studied and highlighted in scientific literature.

PROMISING TRENDS AND FUTURE PROSPECTS

One of the emerging trends for modifying the surface of PDMS is surface nanotexturization which involves creating nanostructured patterns on the surface increasing the surface area available for interactions with water, resulting in greater hydrophilicity, and provides greater durability, precise control over surface characteristics and biological compatibility. However, this process is more expensive for small-scale production. The deposition of thin films of nanomaterials, such as metal oxides or conductive polymers, has better uniformity and compatibility with manufacturing processes, as it is versatile and compatible with a variety of manufacturing processes, as well as having a wide range of materials, providing greater flexibility in the choice of materials to meet the specific demands of each application. Combining different methods to take advantage of the individual benefits of each is also an option. However, this process becomes more complex.

CONCLUSIONS

This detailed review on the surface wettability of polydimethylsiloxane (PDMS) addresses the importance and complexity of surface modification techniques to alter the natural hydrophobicity of this material. Four main strategies are traditionally used: oxygen plasma treatment, addition of surfactants, UV-ozone treatment and incorporation of nanomaterials. These techniques are widely employed due to their greater availability of information, lower complexity and reduced cost compared to new approaches. Each method has advantages and challenges. Oxygen plasma treatment is effective in increasing hydrophilicity by introducing polar functional groups through oxidation reactions. The addition of surfactants allows for a versatile modification of wettability, with the choice and concentration of these agents being decisive in achieving the desired properties. UV-ozone treatment stands out for increasing the surface

energy, promoting oxidation and generating hydrophilic functional groups. The incorporation of nanomaterials into PDMS matrices is promising for adjusting surface properties through controlled distribution and interfacial interactions. In the future, the combination of these techniques and the use of new emerging approaches could meet the needs of various areas at a lower cost and with less complexity.

REFERENCES

Neves, L. B., Afonso, I. S., Nobrega, G., Barbosa, L. G., Lima, R. A., Ribeiro, J.E. A Review of Methods to Modify the PDMS Surface Wettability and Their Applications. *Micromachines*, 2024, 15(6), 670. <https://doi.org/10.3390/MI15060670>

Souza, A., Ribeiro, J., Lima, R. Manufacturing process of a brain aneurysm biomodel in PDMS using rapid prototyping. *VipIMAGE 2019: Proceedings of the VII ECCOMAS Thematic Conference on Computational Vision and Medical Image Processing*, 2019, pp. 671-676, Porto. https://doi.org/10.1007/978-3-030-32040-9_69

Microfabrication of a capillary-driven microfluidic device: Surface wettability

Inês Ramos^{1,*}, Margarida Gonçalves^{2,3}, Rui Lima^{1,4,5}, Diana Pinho^{2,3}

¹MEtRICs, Mechanical Engineering Department, University of Minho, Campus de Azurém, 4800-058 Guimarães, Portugal

²Microelectromechanical Systems Research Unit, CMEMS-UMinho, University of Minho, Campus de Azurém, 4800-058 Guimarães, Portugal

³LABBELS—Associate Laboratory, 4800-122 Braga, Portugal, and 4800-058 Guimarães, Portugal

⁴CEFT, Faculty of Engineering, University of Porto, Rua Dr. Roberto Frias, 4200-465 Porto, Portugal

⁵ALiCE, Faculty of Engineering, University of Porto, Rua Dr. Roberto Frias, 4200-465 Porto, Portugal

(*)**Email:** PG50438@alunos.uminho.pt

ABSTRACT

Polydimethylsiloxane (PDMS) is commonly used in microfluidic devices due to its optical clarity, biocompatibility, and ease of fabrication. However, its inherent hydrophobicity limits its effectiveness in applications that rely on fluid transport. Surface modification techniques have been explored to address this limitation, with the objective of enhancing the wettability of PDMS surfaces. This study investigates the use of surfactants, namely PEO, incorporated in bulk in the PDMS mixture to improve its hydrophilicity. Water contact angle (WCA) measurements were used to assess the effectiveness of these modifications. Initial results indicated that PDMS modified with PEO demonstrated a significant reduction in WCA, suggesting improved hydrophilicity immediately after fabrication.

Keywords: Polydimethylsiloxane (PDMS); Surface Modification; Hydrophilicity; Surfactants (PEO).

INTRODUCTION

Microfluidics, a rapidly growing field with the potential to revolutionize diagnostics and fluid manipulation, relies on the precise control of fluid behaviour in microscale environments. Among the various types of microfluidic systems, capillary-driven devices, which utilize the natural force of capillary action to transport fluids, hold significant promise for a range of biomedical applications, such as point-of-care diagnostics and lab-on-a-chip technologies (Whitesides, 2006). The ability of these systems to function without external power sources makes them particularly attractive for portable and low-cost medical devices. However, the successful implementation of capillary-driven microfluidics depends heavily on surface properties, particularly surface wettability, as it directly influences fluid flow and behaviour in confined channels (Catarino et al., 2019).

PDMS has been the material of choice for microfluidic devices since the 1990s, due to its optical transparency, ease of fabrication, biocompatibility, and gas permeability (Convery & Gadegaard, 2019). Its low production cost, without the need for expensive clean-room facilities, further enhances its appeal. However, PDMS's inherent hydrophobicity limits its use with biological samples, causing unwanted protein adsorption and reducing efficiency in fluid transport and detection (Gökaltun et al., 2019). To address this, surface modifications like bulk modification or plasma treatment have been explored to improve hydrophilicity (Vlachopoulou et al., 2009).

Despite their potential, many of these techniques face challenges related to stability and long-term effectiveness.

In this study, we aim to address the limitations of PDMS in capillary-driven microfluidic devices by improving its surface wettability through bulk modification. By incorporating hydrophilic agents into the PDMS bulk material, we seek to achieve a more stable, hydrophilic surface. The effectiveness of these modifications was evaluated by measuring the water contact angle (WCA) of different PDMS samples, with the goal of identifying the optimal treatment for enhancing fluid flow in microfluidic channels. Additionally, the capillary flow behaviour of fluids in modified and unmodified PDMS channels will be studied to assess the impact of surface wettability on device performance. The findings from this work have the potential to improve the design and functionality of microfluidic devices for biomedical applications, where precise fluid control is essential.

METHODS

The first step in manufacturing microfluidic device moulds involves creating patterns using computer-aided design (CAD) software. For the capillary microfluidic device, Solid Edge was used. The channel features of a width of 0.5mm, a depth of 0.2mm, and inlets and outlets with a diameter of 0.4mm. This geometry was intended for capillarity tests in a closed channel regime, Figure 1.

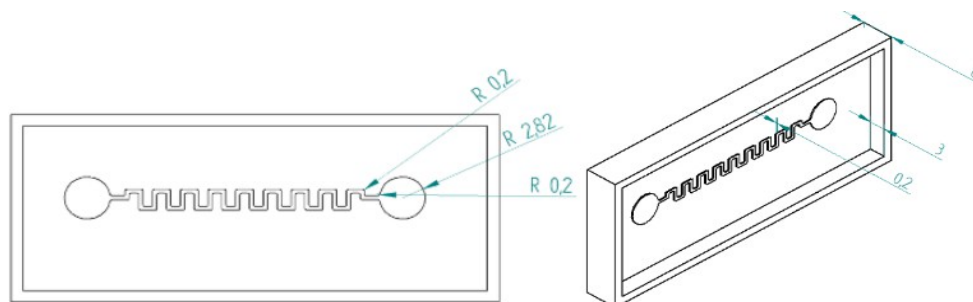

Figure 1 - Drawing views of the designed microfluidic geometry (mm).

The moulds for the microfluidic devices were printed using the *ANYCUBIC PHOTON D2*, which employs SLA technology and UV light for curing. Two software programs were utilized: *CHITUBOX V1.9.5* for defining key printing parameters, such as layer exposure time, and *Anycubic Photon Workshop V3.1.4* for file finalization. A translucent photosensitive resin was selected. Post-printing, excess resin was removed by cleaning the moulds with isopropyl alcohol before solidification. This was followed by a 10-minute cleaning in the *ANYCUBIC Wash & Cure Plus* to ensure accuracy. Subsequently, the molds underwent a two-hour UV curing cycle in the same *ANYCUBIC* machine. After that, molds were exposed to 80 °C in an oven for 24 hours to enhance rigidity and structural integrity. Untreated PDMS and PDMS modified with PEO in different concentrations (1%, 2.5% and 5%) were mixed in a 10:1 ratio and degassed in a vacuum pump. The mixtures were poured into molds and cured at 80 °C for 40 minutes (untreated) or 1 hour 20 minutes (modified). After demolding, the surfaces were cleaned and sealed with scotch tape. A thin PDMS layer was applied for sealing, cured for 10 minutes (untreated) or 25 minutes (modified), and then the channels were sealed. Finally, the devices were placed in the oven for an additional 30 minutes to strengthen the bond before capillarity testing. This process is illustrated in Figure 2.

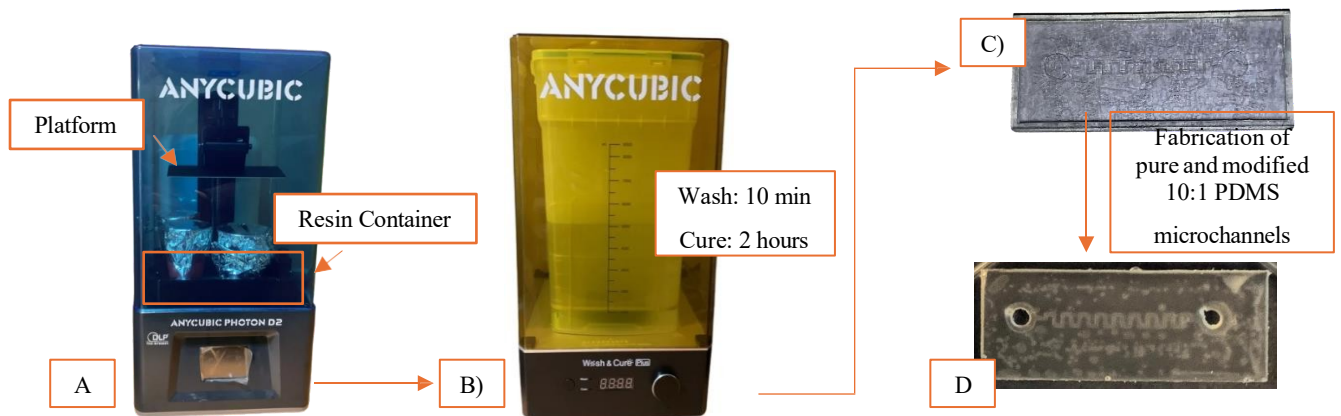

Figure 2 – Schematic representation of the fabrication process for microfluidic devices. A) *ANYCUBIC PHOTON D2 printer*, B) *ANYCUBIC Wash & Cure Plus*, C) Printed *Fillet* mold and D) Adhered microchannel, ready for capillary tests.

RESULTS

WCA Analysis of Bulk-Modified PDMS Samples

Water contact angle measurements were conducted on prefabricated PDMS samples, both in their pure form and bulk-modified states, to assess how different surface modifications impact wettability. The primary objective was to determine which concentration of PEO—1%, 2.5%, or 5%—was most effective in enhancing hydrophilicity over time, based on WCA results and optical quality. The results, as shown in Figure 3, indicated that all PEO concentrations significantly reduced the WCA over time. For example, the 5% PEO concentration achieved the lowest WCA of $(20.1 \pm 1.4)^\circ$ after one week, while untreated PDMS maintained a consistent WCA of $(109.4 \pm 2.4)^\circ$, confirming its hydrophobic nature. Higher surfactant concentrations consistently led to more pronounced hydrophilic effects, with PEO 5% showing significantly lower WCA values compared to the lower concentrations of PEO 1% and PEO 2.5%. However, while higher PEO concentrations resulted in lower WCAs, indicating increased hydrophilicity, they also caused greater opacity. Since transparency is crucial for microfluidic devices, the 2.5% concentration was chosen for further microchannel fabrication. This concentration offered favorable WCA measurements while maintaining sufficient transparency, allowing clear visualization of fluids within the channels without compromising optical quality.

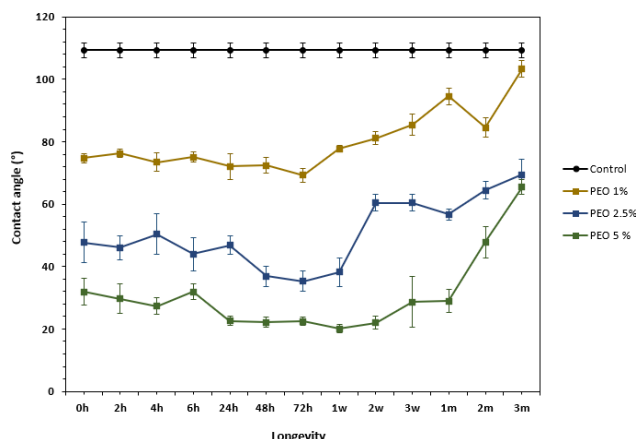

Figure 3 - Graphical display of the outcomes from 10:1 surfactant treated samples, in bulk measurements of the CA using the tensiometer and SCA20 software at room temperature with a 10 μ L drop of pure water.

Capillarity Tests

Capillary flow tests highlighted clear differences between the unmodified and PEO- modified PDMS channels. As expected, unmodified PDMS, being hydrophobic, showed no fluid movement, with the drop at the inlet remaining stationary. In contrast, the channel modified with PEO at concentration of 2.5% exhibited immediate fluid flow, indicating enhanced hydrophilicity. Flow times for these PEO modified channel are illustrated in Table 1, showing the progression over four weeks. Initially, at 0h, PEO 2.5% showed a flow time of 1 min 29 s, indicating improved wettability. After one week, this hydrophilicity increased further, with a reduced flow time of 1 min 13 s. However, by the third week, the flow time increased to 2 min, and by the fourth week, it reached 3 min, reflecting a gradual loss of hydrophilicity over time as the PDMS surface began to revert to its natural hydrophobic state. This highlights the limitation with surface modifications in PDMS, where its hydrophilicity diminishes over time. The increase in flow times over the weeks demonstrates this reversion, with the most significant loss occurring by fourth week. Despite this decline, PEO 2.5% maintained a favourable balance between hydrophilicity and optical clarity, making it suitable for short-term microfluidic applications where rapid fluid flow is critical.

Table 1 - Timepoints measurements for PDMS modified with PEO 2.5%.

Modification	0h	1 week	3 weeks	4 weeks
PEO 2.5%	1 min 29 s	1min 13s	2 min	3 min

CONCLUSIONS

This study successfully modified PDMS surfaces by incorporating PEO to enhance wettability and improve fluid transport in microfluidic devices. Water contact angle measurements and capillary flow tests confirmed that PEO-modified PDMS significantly increased hydrophilicity. PEO 2.5% offered the best balance between hydrophilicity and optical clarity, making it suitable for short-term applications. However, hydrophilicity declined over time as PDMS reverted to its hydrophobic state. These findings underscore the critical role of surfactant selection in optimizing PDMS for capillary-driven microfluidic devices, particularly in biomedical applications where both transparency and consistent fluid control are essential.

ACKNOWLEDGMENTS

This work was supported by the projects 2022.02085.PTDC (<https://doi.org/10.54499/2022.02085.PTDC>), 2022.06207.PTDC (<https://doi.org/10.54499/2022.06207.PTDC>), and PTDC/EEI-EEE/2846/2021 (<https://doi.org/10.54499/PTDC/EEI-EEE/2846/2021>) through national funds (OE) within the scope of the Scientific Research and Technological Development Projects (IC&DT) program in all scientific domains (PTDC) through the FCT (I.P.). Diana Pinho also thanks the FCT for individual funding (2021.00027.CEECIND/CP1664/CT0007; <https://doi.org/10.54499/2021.00027.CEECIND/CP1664/CT0007>).

REFERENCES

- Catarino, S. O., Rodrigues, R. O., Pinho, D., Miranda, J. M., Minas, G., & Lima, R. (2019). Blood Cells Separation and Sorting Techniques of Passive Microfluidic Devices: From Fabrication to Applications. *Micromachines*, 10(9). <https://doi.org/10.3390/mi100905>
- Convery, N., & Gadegaard, N. (2019). 30 years of microfluidics. *Micro and Nano Engineering*, 2, 76–91. <https://doi.org/https://doi.org/10.1016/j.mne.2019.01.003>
- E. (2009). Effect of surface nanostructuring of PDMS on wetting properties, hydrophobic recovery and protein adsorption. *Microelectronic Engineering*, 86(4), 1321–1324. <https://doi.org/https://doi.org/10.1016/j.mee.2008.11.050>
- Gökaltun, A., Kang, Y. B. (Abraham), Yarmush, M. L., Usta, O. B., & Asatekin, A. (2019). Simple Surface Modification of Poly(dimethylsiloxane) via Surface Segregating Smart Polymers for Biomicrofluidics. *Scientific Reports*, 9(1), 7377. <https://doi.org/10.1038/s41598-019-43625-5>
- Vlachopoulou, M.-E., Petrou, P. S., Kakabakos, S. E., Tserepi, A., Beltsios, K., & Gogolides, Whitesides, G. M. (2006). The origins and the future of microfluidics. *Nature*, 442(7101), 368–373. <https://doi.org/10.1038/nature05058>

Microfabrication of a capillary flow-driven microfluidic plasma separator

Margarida Gonçalves^{1,2*} and Diana Pinho^{1,2}

¹Microelectromechanical Systems Research Unit, CMEMS-UMinho, University of Minho, Campus de Azurém, 4800-058 Guimarães, Portugal

²LABBELS—Associate Laboratory, 4800-122 Braga, Portugal, and 4800-058 Guimarães, Portugal

(*)**Email:** b13836@cmems.uminho.pt

ABSTRACT

In microfluidic devices used for biomedical applications, inadequate surface wetting leads to the inefficient flow of fluids through channels. In this work, it was developed a capillary driven flow geometry, with the fluid flow facilitated by a PDMS surface wettability modification. Different designs of microfluidic devices for passive blood plasma separation were developed and fabricated using 3D printing and replica molding. Bulk surface modification with polyethylene oxide (PEO) was applied to PDMS mixture. Contact angle (CA) measurements were obtained and capillarity flow tests performed. The addition of the surfactant, such as PEO, modify the PDMS surface to hydrophilic. The results obtained, particularly with the 2.5% PEO bulk surface modification, were encouraging to be applied for plasma separation devices.

Keywords: Microfluidic Devices; Surface Wettability Modification; Polyethylene Oxide (PEO); Blood Plasma Separation.

INTRODUCTION

Passive and active microfluidic devices are used in many biomedical and chemical applications to support fluid mixing, particle manipulations, and molecular detection. A passive separation happens without any external forces aiding the fluid movement. It occurs through different techniques such as hydrodynamic (Rodríguez-Villarreal et al., 2010) and hemodynamic (Kersaudy-Kerhoas et al., 2010; Marchalot et al., 2014; Prabhakar et al., 2015; Sollier et al., 2010; Yang et al., 2006) phenomena, the addition of physical-filtrations microstructures (Chen et al., 2008; Kim et al., 2010), sedimentation (Tachi et al., 2009; Zhang et al., 2012), and with surface wettability gradients (Maria et al., 2017; Ramalingam et al., 2009).

The development of microfluidic devices for passive plasma separation aimed to efficiently separate plasma from whole blood without the need for external forces or active components. Those devices should enable the isolation of plasma from a small volume of human blood, which contains important biomarkers related to certain diseases for subsequent analysis. Polydimethylsiloxane (PDMS) is the most commonly used material in the fabrication of microfluidic devices. However, it has a hydrophobic nature (CA with water of 110°), leading to poor wetting behaviour and small molecule adsorption. Therefore, it is of high interest develop long-term PDMS surface modification methods.

METHODS

A method for obtaining hydrophilic PDMS surfaces to enhance fluid flow was developed using surface modification through bulk mixture. This method, as seen in Figure 1, involves mixing the chosen surfactant Polyethylene Oxide (PEO) with the polymer base and curing agent while still in an aqueous state. The procedure for producing the PDMS mixture was repeated, at a 10:1 (*w/w*) ratio, with different percentages of surfactant, 2.5 and 5% (*w/v*), added based on the total volume of the PDMS mixture. Water contact angle (WCA) measurements were performed to evaluate the surface wettability.

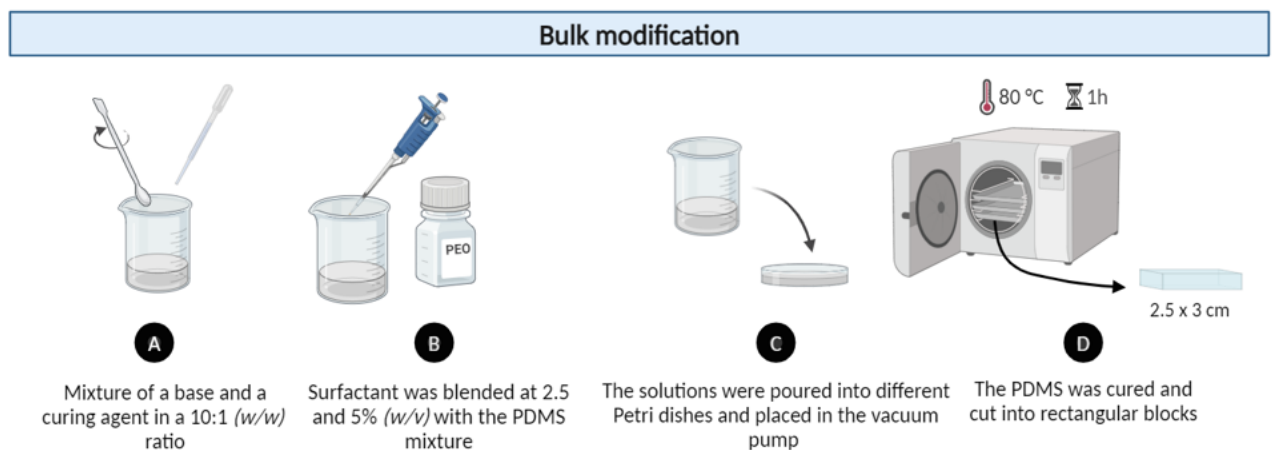

Figure 6 - Experimental procedure of PDMS samples with bulk modification using 2.5 and 5 % (*w/v*) of surfactant PEO. Adapted from (Gonçalves et al., 2024).

Based on previous works of Maria et al., 2017 and Ramalingam et al., 2009, two microchannel molds were designed (Figures 2A, I and II) aiming to separate the plasma from the blood through hemodynamic phenomena and sedimentation, with the aid of hydrophilic surface property, by adding 2.5% of PEO surfactant to the PDMS. The microfluidic devices were fabricated using 3D printed molds by stereolithography technique (Figure 2B), and furthermore, a replica molding method was applied (Figure 2C).

The molds printing cross several steps. Briefly, the microchannels drawings are transformed into .STL to be sent to the 3D printer pre-processing software. A specific photosensitive resin is used in the printing process and the high-resolution parameters were defined. Support structures and object orientation (45°) are essential to provide stability and resistance during the printing of each object layer. The molds undergo a 10-minute ultrasonic treatment to remove excess resin, and subsequently, a 2-hour UV curing session that improves their structural stability. Lastly, the supports are removed, and the molds exposed to a 24-hour thermal treatment at 80 °C in an oven.

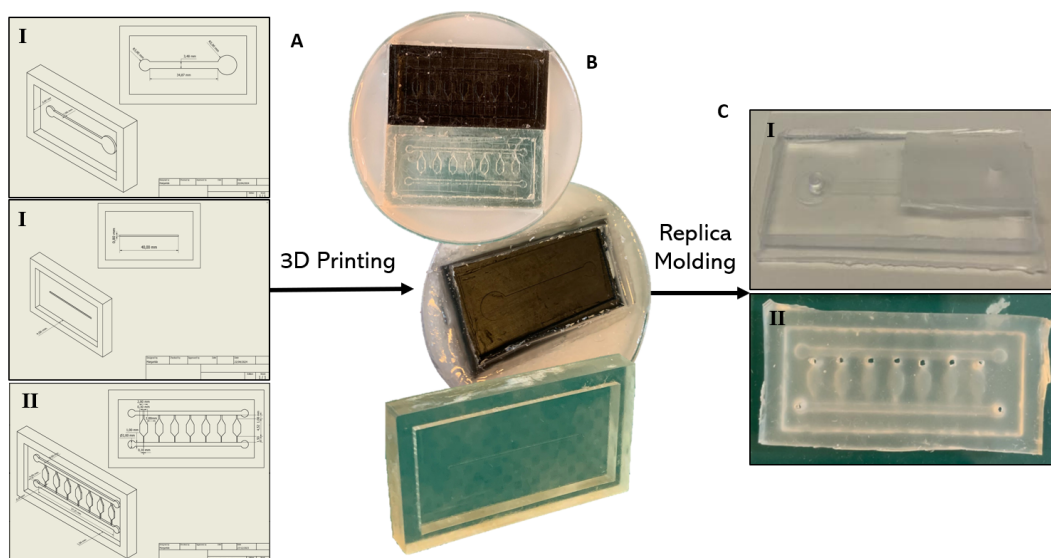

Figure 7 - A) Devices design; B) 3D printing molds, and C) assembling of the microfluidic devices.

Additionally, capillarity tests were performed on the final devices to evaluate fluid flow, both with and without surface modification. The inlet was filled with a 100 μL drop of blue-colored distilled water, and the amount of time it took for the fluid to flow out was timed.

RESULTS

The results plotted in the Figure 3 demonstrated that the addition of PEO reduced the values of CA, i.e. increased the PDMS hydrophilicity. Despite having lower CAs and being more hydrophilic, the 5% PEO samples had low PDMS transparency. The optical property is of high importance when microscope visualizations within the devices are needed.

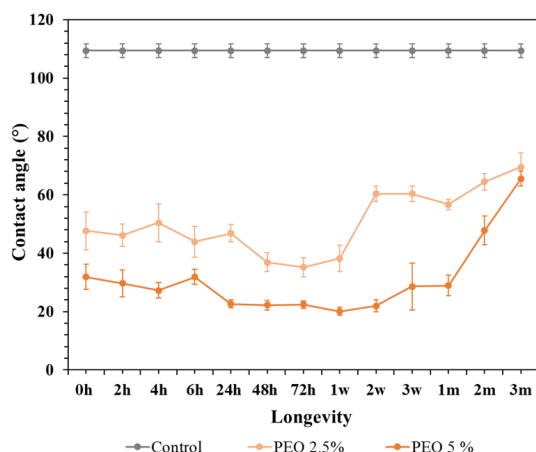

Figure 3 - Water CA results from control and PEO bulk-modified PDMS samples, with 10:1 ratio.

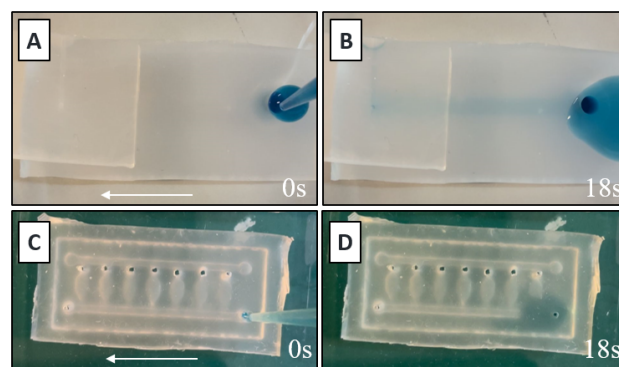

Figure 4 - Devices modified with 2.5% PEO: (A) Device I at 0s and (B) after 18s. (C) Device II at 0s and (D) at 18s.

The 2.5% PEO surface modification was used to fabricate the PDMS devices following the CA findings. Without surface modification, the control devices lacked fluid movement. At 18

seconds, the fluid in the 2-layer device I (Figure 4A and B) reached the output, demonstrating a continuous flow. The fluid flow through device II was observed with more difficulty and it was also observed ineffective adhesion. The adhesion difficulties may occur due to the resin used to print the respective mold.

CONCLUSIONS

The outcomes were encouraging, especially when the 2.5% PEO surface modification was used. The devices that were modified exhibited improved fluid mobility and advancements in passive plasma separation. The optimization of new devices is ongoing to enhance the existing methods.

Tests of blood flow will be conducted on the microfluidic device, that provides faster fluid flow, to improve plasma separation.

ACKNOWLEDGMENTS

This work was supported by the projects 2022.02085.PTDC (<https://doi.org/10.54499/2022.02085.PTDC>), and 2022.06207.PTDC (<https://doi.org/10.54499/2022.06207.PTDC>) through national funds (OE) within the scope of the Scientific Research and Technological Development Projects (IC&DT) program in all scientific domains (PTDC) through the FCT (I.P.). Diana Pinho also thanks the FCT for individual funding 2021.00027.CEECIND/CP1664/CT0007 (<https://doi.org/10.54499/2021.00027.CEECIND/CP1664/CT0007>).

REFERENCES

- Chen, X., Cui, D. F., Liu, C. C., & Li, H. (2008). Microfluidic chip for blood cell separation and collection based on crossflow filtration. *Sensors and Actuators, B: Chemical*, 130(1). <https://doi.org/10.1016/j.snb.2007.07.126>
- Gonçalves, M., Gonçalves, I. M., Borges, J., Faustino, V., Soares, D., Vaz, F., Minas, G., Lima, R., & Pinho, D. (2024). Polydimethylsiloxane Surface Modification of Microfluidic Devices for Blood Plasma Separation. *Polymers*, 16(10). <https://doi.org/10.3390/polym16101416>
- Kersaudy-Kerhoas, M., Kavanagh, D. M., Dhariwal, R. S., Campbell, C. J., & Desmulliez, M. P. Y. (2010). Validation of a blood plasma separation system by biomarker detection. *Lab on a Chip*, 10(12). <https://doi.org/10.1039/b926834k>
- Kim, Y. C., Kim, S. H., Kim, D., Park, S. J., & Park, J. K. (2010). Plasma extraction in a capillary-driven microfluidic device using surfactant-added poly(dimethylsiloxane). *Sensors and Actuators, B: Chemical*, 145(2). <https://doi.org/10.1016/j.snb.2010.01.017>
- Marchalot, J., Fouillet, Y., & Achard, J. L. (2014). Multi-step microfluidic system for blood plasma separation: Architecture and separation efficiency. *Microfluidics and Nanofluidics*, 17(1), 167–180. <https://doi.org/10.1007/s10404-013-1296-4>
- Maria, M. S., Rakesh, P. E., Chandra, T. S., & Sen, A. K. (2017). Capillary flow-driven microfluidic device with wettability gradient and sedimentation effects for blood plasma separation. *Scientific Reports*, 7. <https://doi.org/10.1038/srep43457>
- Prabhakar, A., Kumar, Y. V. B. V., Tripathi, S., & Agrawal, A. (2015). A novel, compact and efficient microchannel arrangement with multiple hydrodynamic effects for blood plasma separation.

Microfluidics and Nanofluidics, 18(5–6). <https://doi.org/10.1007/s10404-014-1488-6>

Ramalingam, N., Liu, H. B., Dai, C. C., Jiang, Y., Wang, H., Wang, Q., M Hui, K., & Gong, H. Q. (2009). Real-time PCR array chip with capillary-driven sample loading and reactor sealing for point-of-care applications. *Biomedical Microdevices*, 11(5). <https://doi.org/10.1007/s10544-009-9318-4>

Rodríguez-Villarreal, A. I., Arundell, M., Carmona, M., & Samitier, J. (2010). High flow rate microfluidic device for blood plasma separation using a range of temperatures. *Lab on a Chip*, 10(2). <https://doi.org/10.1039/b904531g>

Sollier, E., Cubizolles, M., Fouillet, Y., & Achard, J. L. (2010). Fast and continuous plasma extraction from whole human blood based on expanding cell-free layer devices. *Biomedical Microdevices*, 12(3). <https://doi.org/10.1007/s10544-010-9405-6>

Tachi, T., Kaji, N., Tokeshi, M., & Baba, Y. (2009). Simultaneous separation, metering, and dilution of plasma from human whole blood in a microfluidic system. *Analytical Chemistry*, 81(8). <https://doi.org/10.1021/ac802434z>

Yang, S., Ündar, A., & Zahn, J. D. (2006). A microfluidic device for continuous, real time blood plasma separation. *Lab on a Chip*, 6(7). <https://doi.org/10.1039/b516401j>

Zhang, X. B., Wu, Z. Q., Wang, K., Zhu, J., Xu, J. J., Xia, X. H., & Chen, H. Y. (2012). Gravitational sedimentation induced blood delamination for continuous plasma separation on a microfluidics chip. *Analytical Chemistry*, 84(8). <https://doi.org/10.1021/ac3003616>

Development and fabrication of a microfluidic device for mechanical characterization of malaria-infected red blood cells

Margarida Ferreira^{1*}, Bruno Freitas², Vitória Baptista^{1,2}, Diana Pinho^{1,3}, Graça Minas^{1,3}, Maria Isabel Veiga², Vera Faustino^{1,3}, Susana O. Catarino^{1,3*}

1 CMEMS – Center for Microelectromechanical Systems, University of Minho, Guimarães, Portugal

2 ICVS/3Bs – PT Government Associate Laboratory, University of Minho, Braga/Guimarães, Portugal

3 LABBELS – Associate Laboratory, University of Minho, Braga/Guimarães, Portugal

(*) **Email:** pg50589@alunos.uminho.pt and scatarino@dei.uminho.pt

ABSTRACT

This work reports the design and fabrication of a polymeric microfluidic device, with a hyperbolic contraction, to promote extensional flow and allow the single cell mechanical characterization, *in vitro*, of healthy and malaria-infected red blood cells (RBCs). The obtained results show an extensional flow profile of the velocity across the microchannel for both healthy and infected RBCs, while the ability of the cells to deform was significantly reduced for the malaria infected samples.

Keywords: Microfluidic Device; Extensional Flow; Red Blood Cells (RBCs); Malaria Infection.

INTRODUCTION

Every year, malaria, caused by the *Plasmodium falciparum* parasite, affects millions of people worldwide, posing a significant global health challenge (Baptista, 2023). During the progression of malaria infection, the parasite induces several biomechanical and physiological modifications in red blood cells (RBCs). One of the most notable changes is the conversion of haemoglobin into hemozoin, a ferrous crystal with distinct paramagnetic and optical properties, which is absent in healthy individuals. Additionally, infected RBCs undergo a significant increase in stiffness and a reduction in deformability compared to their healthy counterparts (Hou, 2010). These alterations impair the RBCs' ability to navigate through the microvasculature, contributing to the pathophysiology of the disease.

Microfluidic devices have emerged as powerful tools for mechanically characterizing the deformability and flow velocity of RBCs, offering insights into the biomechanical changes induced by malaria infection (Faustino, 2019). In this study, we designed and fabricated a microfluidic device to characterize, *in vitro*, the mechanical behavior of *P. falciparum*-infected RBCs with parasitaemia levels exceeding 90%, and compared these findings to healthy RBCs. The microdevice, illustrated in Figure 1, was fabricated using polydimethylsiloxane (PDMS) through soft lithography and replica moulding techniques, with a SU-8 mould serving as the template. The device features hyperbolic contractions designed to subject the RBCs to extensional flow, forcing them to deform as they pass through narrow constrictions (Faustino, 2019; Kriebel, 2023). The microchannels have a total length of 1.25 cm, with the contraction zone measuring 400 μm in length and a minimum width of 20 μm . This design enables precise measurement of the deformability and flow dynamics of both infected and healthy RBCs, providing valuable data on the biomechanical impact of malaria infection. By leveraging

microfluidic technology, this work aims to deepen our understanding of the disease's progression and contribute to the development of novel diagnostic and therapeutic strategies.

RESULTS

The performance of the fabricated microchannel was assessed through the analysis of microflows ($2 \mu\text{L}/\text{min}$) of healthy and malaria-infected RBCs in a setup comprising a set of syringe pumps, a high-speed camera and an inverted microscope, and data was analysed in *ImageJ* software. Results (Figure 2) showed that the cells are forced to deform as they approach the hyperbolic contraction (increasing their deformation index (DI)) and recover their initial shape after the contraction. It was observed that malaria infected RBCs have a lower DI than the healthy RBCs, proving their stiffness, while the velocity across the microchannel is similar for both samples, with a linear increase of velocity across the contraction (extensional flow pattern), and its sudden velocity reduction in the recovery region of the microchannel.

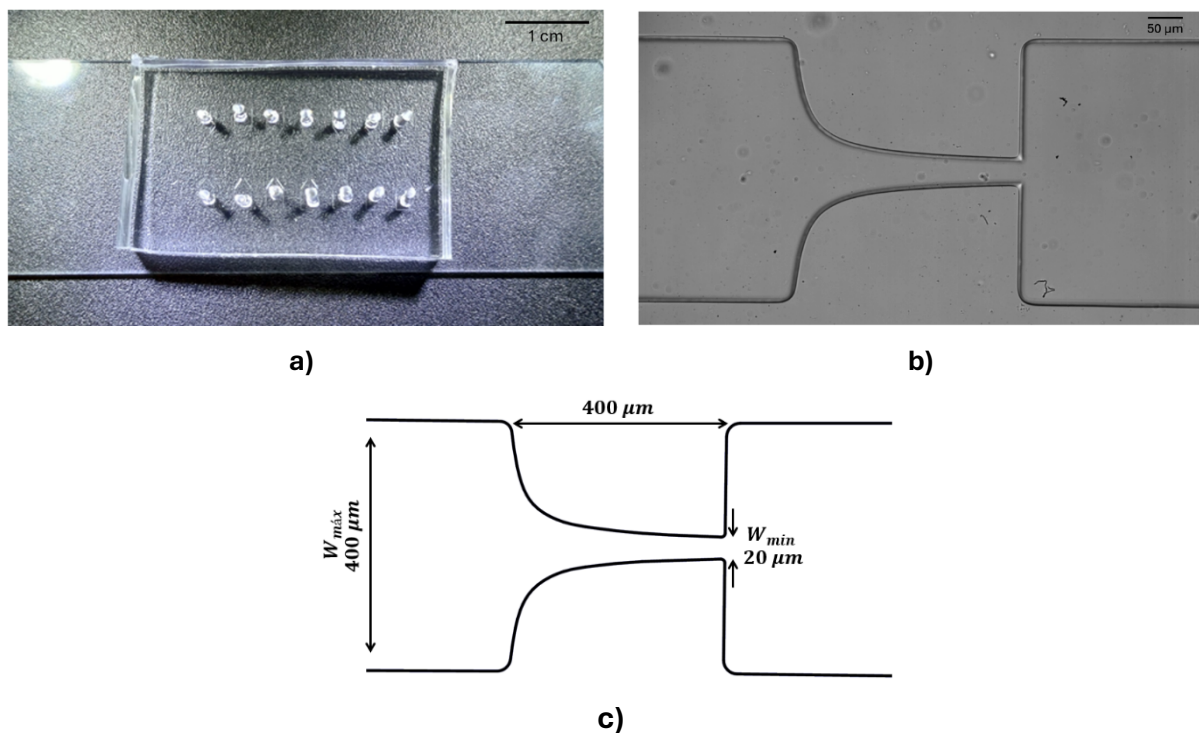

Figure 3 - a) PDMS mould of the microfluidic channels in set of 7, where the inlets and outlets punch holes are visible; b) Microscope image (obj. 20×) of the hyperbolic contraction of the PDMS microchannel; c) Geometry and main dimensions of the microchannel

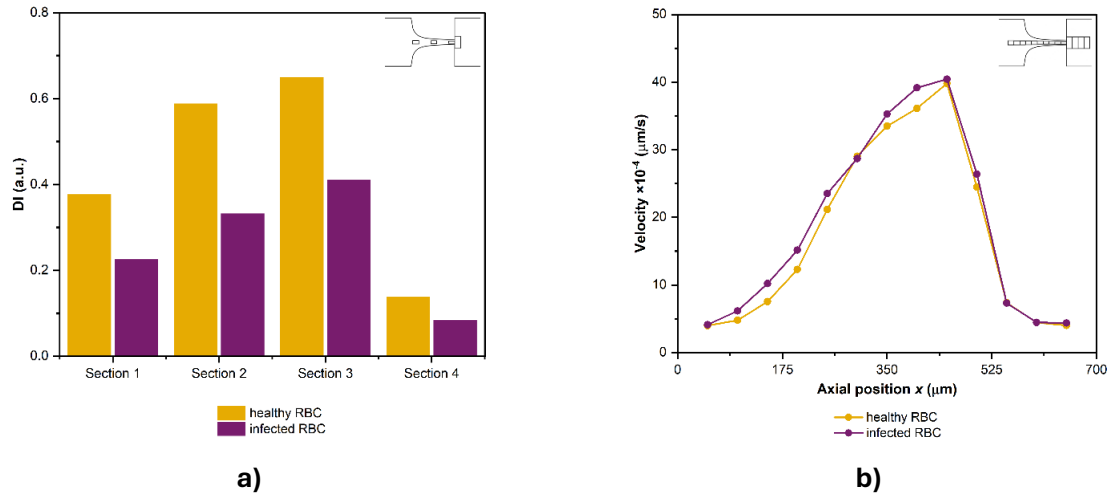

Figure 4 - a) Deformation index (DI) of the healthy and malaria-infected red blood cells across the microchannel; b) Velocity ($\mu\text{m/s}$) of the healthy and malaria-infected red blood cells across the microchannel.

CONCLUSIONS

A microfluidic device was designed and fabricated to allow the mechanical characterization of healthy and malaria infected RBCs. As expected, the deformability of malaria infected RBCs decreases significantly compared to healthy RBCs, while the velocity is dependent on the flow and not affected by the cells' rigidity. Future works intend to evaluate, in these microchannels, how different cells, with different paramagnetic nucleus (for instance, due to the presence of hemozoin), respond to non-magnetic and magnetic nanoparticles, in order to study the potential use of nanoparticles as specific nanocarriers for antimalarial drugs.

ACKNOWLEDGMENTS

This study has been funded by a grant 2023 from the European Society of Clinical Microbiology and Infectious Diseases (Europäische Gesellschaft für klinische Mikrobiologie und Infektionskrankheiten) (ESCMID) to CATARINO. This study was supported by the Portuguese Foundation for Science and Technology (FCT) under the CMEMS-UMinho Strategic Project UIDB/04436/2020 and UIDP/04436/2020, and by LABELS – Associate Laboratory in Biotechnology, Bioengineering and Microelectromechanical Systems, LA/P/0029/2020.

REFERENCES

Baptista, V., Silva, M., Ferreira, G.M., Calçada, C., Minas, G., Veiga, M.I., Catarino, S.O. (2023). Optical spectrophotometry as a promising method for quantification and stage differentiation of *Plasmodium falciparum* parasites. *ACS Infectious Diseases*, 9(1): 140-149

Faustino, V., Rodrigues, R.O., Pinho, D., Costa, E., Santos-Silva, A., Miranda, V., Amaral, J.S., Lima, R. (2019). A Microfluidic Deformability Assessment of Pathological Red Blood Cells Flowing in a Hyperbolic Converging Microchannel. *Micromachines*, 10(10): 645

Hou, H. W., Bhagat, A., Chong, A. G. L., Mao, P., et al. (2010). Deformability based cell margination—A simple microfluidic design for malaria-infected erythrocyte separation. *Lab on a Chip*, 10(19): 2605

Kriebel, J., Gonçalves, I.M., Baptista, V., Veiga, M.I., Minas, G., Lima, R., Catarino, S.O. (2023). Extensional flow for assessing the effect of nanocarriers on the mechanical deformability of red blood cells. *Experimental Thermal and Fluid Science*, 146: 110931.

3D Hollow microneedles fabrication for microfluidic applications

V. Faustino^{1,2,*}, R. Maia³, D. Pinho^{1,2}, R. Lima^{4,5,6} and G. Minas^{1,2}

¹Center for MicroElectromechanical Systems (CMEMS-UMinho), University of Minho, Campus de Azurém, 4800-058 Guimarães, Portugal

²LABBELS—Associate Laboratory, Braga/Guimarães, Portugal

³ Department of Biomaterials & Biomedical Technology, University Medical Center Groningen, University of Groningen, The Netherlands

⁴MEtRICs, Mechanical Engineering Department, University of Minho, Campus de Azurém, 4800-058 Guimarães, Portugal

⁵CEFT, Faculdade de Engenharia da Universidade do Porto (FEUP), R. Dr. Roberto Frias, 4200-465 Porto, Portugal

⁶ALiCE—Associate Laboratory in Chemical Engineering, Faculty of Engineering, University of Porto, Rua Dr. Roberto Frias, 4200-465 Porto, Portugal

(***Email:** vera.faustino@cmems.uminho.pt)

ABSTRACT

The development of 3D hollow microneedles has garnered significant attention for their potential in microfluidic applications, particularly in drug delivery, diagnostics, and biomedical research. These microneedles offer a minimally invasive approach for fluid extraction and precise delivery of therapeutic agents, bypassing traditional barriers in the skin. This study focuses on fabrication of 3D hollow microneedles, exploring the 3D printing method to achieve optimal mechanical strength, biocompatibility, and fluid dynamics. By optimizing design and printing parameters, this work demonstrates how 3D hollow microneedles can enhance microfluidic device performance, presenting a way for advanced applications in healthcare and bioengineering.

Keywords: 3D Hollow Microneedles; Microfluidics; Drug Delivery; 3D Printing.

INTRODUCTION

Microneedles (MNs) have emerged as a transformative technology in biomedical applications (Cárcamo-Martínez et al., 2021), particularly in transdermal drug delivery (Sonetha et al., 2022) and diagnostics (Liu et al., 2020). Their ability to painlessly penetrate the skin offers a significant advantage over conventional needles, especially in applications requiring high precision and low invasiveness. Hollow MN, in particular, allow for direct fluid exchange, making them ideal for both therapeutic and diagnostic microfluidic systems.

The dimensions of MN may vary depending on the application. However, the most common dimensions found in the literature have height ranges between 100 to 1500 μm , with a base width of 50 to 250 μm and a tip diameter of 1 to 30 μm (Waghule et al., 2019). The shape of MNs can also vary including triangular, cylindrical, and pentagonal (Chang et al., 2020). These dimensions play a crucial role in determining the performance and effectiveness of MN systems.

The recent advancements in 3D printing and microfabrication have enabled the creation of highly intricate and functional microneedle designs (Chang et al., 2020). This study focuses on

the fabrication of 3D hollow MNs, using a 3D printing machine, leveraging cutting-edge manufacturing techniques to meet the demanding requirements of microfluidic applications. The primary aim is to ensure biocompatibility and mechanical performance by proper material selection and design parameters.

METHODS

A 3D printer was used to fabricate the mold for the hollow microneedles, consisting of a 4x4 array with hollow dimensions of 400 μm x 1000 μm . The mold was then replicated using PDMS to evaluate the structural integrity and resistance of the microneedles during the demolding process. The fabrication of a 4x4 array of hollow microneedle moulds using a resin-based 3D printing technique is represented in Figure 1.

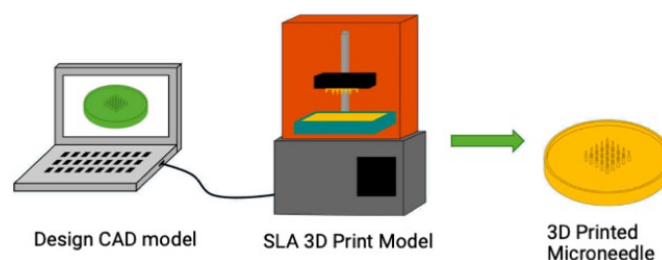

Figure 1 – 3D printing fabrication method.

To obtain the 3D printed molds stereolithography technique was used with a specific photosensitive resin black from anycubic. After printing the mold, a 10-minute ultrasonic treatment to remove excess resin was performed, follow by a smooth surface clean with isopropyl alcohol. After that a cured in an UV chamber for 3h was applied to improve mold structure stability. Next, a new surface treatment by temperature in an oven for 48h at 80°C was performed.

After, a PDMS mixture in ratio of 10:1 was poured over the resin mold. The PDMS was cured in oven at 80°C, for 40 minutes. Finally, it was peeled off and the MN array quality was inspected by microscopy imaging.

RESULTS

Figure 2A illustrates the overall molding process, highlighting the arrangement of hollow MNs and the positioning of the PDMS layer over the resin mold. This setup is designed to facilitate precise replication of the microneedle structures, ensuring accurate dimensions and integrity during the curing and demolding stages.

Figure 2B shows the photographic representation of the resulting 4x4 resin mold, with each MN being distinctly visible. The inset image provides a close-up view of a single hollow microneedle, demonstrating the fidelity of the printing process and the sharpness of the needle tips. This detailed image confirms the successful fabrication of the mold, showing well-defined hollow structures that are essential for fluidic applications. The uniformity of the array indicates that the printing parameters were effectively optimized to produce consistent geometries, ensuring that the final PDMS replicas will have reliable structural characteristics suitable for their intended microfluidic applications.

Figure 2C presents the final 4x4 array of PDMS hollow MNs replicated from the resin mold. The top view in the main image shows the uniform distribution of the hollow MNs across the array,

indicating successful molding and demolding without structural deformation. However, the resin mold suffers some damages in the pillars (structures that will create the hollow MN), during the demolding, which may require some upgrades in the post treatment protocol of the resin mold. The inset to the top right offers a magnified view of a subset of MNs, further highlighting the consistency in shape and size of each hollow MN.

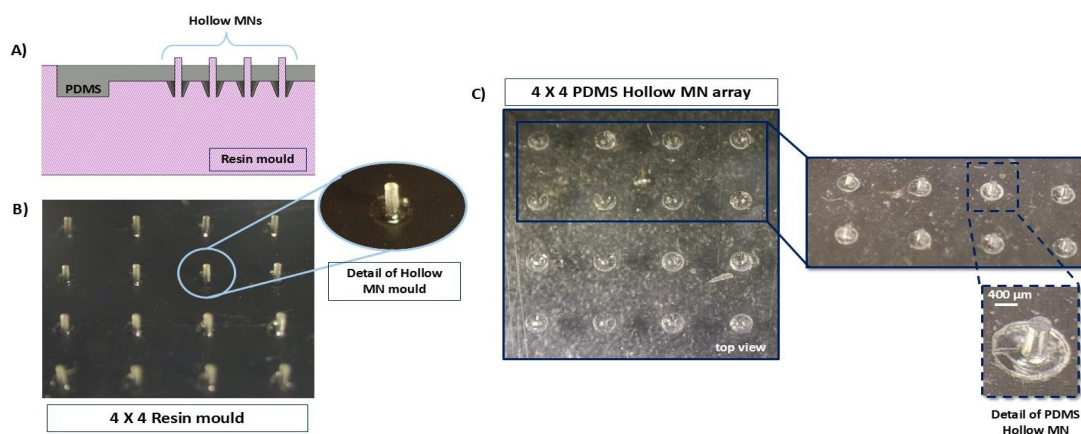

Figure 2 – A) Schematic representation of the PDMS molding process using a 4x4 resin MN mold. The illustration shows the arrangement of hollow MN, where the PDMS layer is cast over the resin mold to replicate the MN structures. (B) Photographic image of the 4x4 resin MN mold after fabrication, with a detailed view highlighting a single hollow MN. The image demonstrates the sharpness and precision of the mold structure, ensuring accurate replication of the hollow cavities necessary for microfluidic applications. Figure C: Top view of the 4x4 PDMS hollow MN array produced from the resin mold. The enlarged view of a selected region shows the uniformity and shape retention of the replicated MNs. The detailed image at the bottom right confirms the successful reproduction of the hollow MN structure with an internal diameter of 400 μm , demonstrating the precision and structural integrity of the PDMS microneedles.

The detailed close-up at the bottom right reveals a single PDMS hollow MN, where the hollow channel is clearly visible. The labelled dimension of 400 μm corresponds to the internal diameter of the needle's hollow section, confirming the accurate reproduction of the original design specifications. This successful replication demonstrates that the PDMS material provided sufficient mechanical support to maintain the hollow structure during demolding, thus validating its suitability for future microfluidic applications.

CONCLUSIONS

The successful fabrication of a 4x4 array of hollow MNs using a 3D-printed resin mold and subsequent replication in PDMS was demonstrated. The PDMS MNs maintained structural integrity and accurate geometry during the demolding process, confirming the robustness of the design. The precise hollow dimensions are essential for reliable fluid transport, making these MNs suitable for microfluidic applications. This work highlights the feasibility of using 3D printing for complex mold designs and establishes a foundation for future development of MN-based systems. Further optimization will focus on enhancing MN durability and exploring alternative materials.

ACKNOWLEDGMENTS

This project was supported by the projects PTDC/EEI-EEE/2846/2021 (<https://doi.org/10.54499/PTDC/EEI-EEE/2846/2021>), and 2022.06207.PTDC (<https://doi.org/10.54499/2022.06207.PTDC>), funded by national funds (OE), within the scope of the Scientific Research and Technological Development Projects (IC&DT) program in all scientific domains (PTDC), through the Foundation for Science and Technology, I.P. (FCT, I.P), by the CMEMS- UMinho Strategic Project UIDB/04436/2020 and UIDP/04436/2020), and by LABELS – Associate Laboratory in Biotechnology, Bioengineering and Microelectromechanical Systems, LA/P/0029/2020.

REFERENCES

Cárcamo-Martínez Á, Mallon B, Domínguez-Robles J, Vora LK, Anjani QK, Donnelly RF. Hollow microneedles: A perspective in biomedical applications. *Int J Pharm* 2021;599. <https://doi.org/10.1016/j.ijpharm.2021.120455>.

Chang KT, Shen YK, Fan FY, Lin Y, Kang SC. Optimal design and fabrication of a microneedle arrays patch. *J Manuf Process* 2020;54:274–85. <https://doi.org/10.1016/j.jmapro.2020.02.024>.

Liu GS, Kong Y, Wang Y, Luo Y, Fan X, Xie X, et al. Microneedles for transdermal diagnostics: Recent advances and new horizons. *Biomaterials* 2020; 232. <https://doi.org/10.1016/j.biomaterials.2019.119740>.

Sonetha V, Majumdar S, Shah S. Step-wise micro-fabrication techniques of microneedle arrays with applications in transdermal drug delivery – A review. *J Drug Deliv Sci Technol* 2022;68. <https://doi.org/10.1016/j.jddst.2022.103119>.

Waghule T, Singhvi G, Dubey SK, Pandey MM, Gupta G, Singh M, et al. Microneedles: A smart approach and increasing potential for transdermal drug delivery system. *Biomedicine and Pharmacotherapy* 2019;109:1249–58. <https://doi.org/10.1016/j.biopha.2018.10.078>.

Study, design, and manufacturing of 3D-printed orthoses

B. Nogueira¹, João Rocha^{1,2}

¹Instituto Politécnico de Bragança, 5300-253, Bragança, Portugal

²GICoS, Instituto Politécnico de Bragança, 5300-253, Bragança, Portugal

(*)**Email:** a51814@alunos.ipb.pt

ABSTRACT

This study demonstrated that, in relation to Additive Manufacturing, Three-Dimensional (3D) Printing is a technology that is increasingly present in everyday life in the manufacturing of parts. In this case, the piece manufactured using 3D printing was a hand orthosis, intended to alleviate the pain of a woman suffering from a medical condition.

This study highlights the growing presence of three-dimensional (3D) printing in everyday life, particularly in the manufacture of customized medical devices. In the field of additive manufacturing (AM), Material Extrusion (MEX), ISO/ASTM 52900:2023, (fused deposition modeling (FDM)) has become a widely used technique due to its affordability, accessibility, and ability to create personalized solutions.

In this case, a 3D-printed hand orthosis was designed to assist a woman suffering from tendinitis in her thumb. The orthosis was designed to reduce pain and provide support to improve her daily functionality. Material Extrusion (MEX), FDM technology was used to build the device layer by layer, resulting in a lightweight yet durable structure tailored to the patient's needs.

One of the key benefits of 3D printing in orthotic design is the ability to create customized, patient-specific solutions at a lower cost than traditional manufacturing. In addition, rapid prototyping allows for quick modifications based on patient feedback, improving comfort and effectiveness. Traditional orthotic manufacturing methods require expensive molds and labor-intensive processes, whereas 3D printing streamlines production, allowing for efficient, scalable, and precise results.

Another advantage of this technique is the wide range of materials available for use in 3D printing. From biodegradable polymers to highly durable composites, the choice of material can be tailored to the specific needs of each patient, ensuring not only comfort but also long-term durability. For example, in this case, PLA was used, a material known for its low cost, ease of printing, and environmental sustainability.

This study reinforces the potential of 3D printing in medical applications and demonstrates how FDM-printed orthotics can help alleviate pain and improve quality of life for people with musculoskeletal conditions. As the technology continues to evolve, personalized healthcare solutions will become more accessible and efficient. The implications of this advancement extend beyond orthotic production, opening possibilities for broader applications in medical fields, including prosthetics, implants, and even tissue engineering.

Keywords: 3D Printing in Orthotics, Material Extrusion (MEX), Fused Deposition Modeling (FDM), Customized Hand Orthosis, Additive Manufacturing in Healthcare

METHODS

An employee at the School of Technology and Management (ESTiG) of the Polytechnic Institute of Bragança (IPB) began experiencing pain when making movements with her hand. After undergoing medical examinations, she was diagnosed with De Quervain's Tenosynovitis, a musculoskeletal condition also known as Tendinitis. This condition primarily affects the tendons of the thumb, particularly the long abductor tendon and the short extensor tendon. Each muscle in the hand consists of tendons, and each tendon is encased in a synovial sheath. In this pathology, the sheath becomes inflamed and thickened, causing pain when moving the thumb.

To alleviate the pain and improve mobility, a 3D-printed splint was created to immobilize the thumb. An orthosis is a medical device designed to reduce pain and enhance mobility—in this case, of the hand. Unlike traditional orthotic solutions that may require multiple fittings and adjustments, 3D printing offers rapid prototyping and precise customization. This technology enables the creation of three-dimensional objects from digital models by applying material layer by layer until the object is complete. The ability to manufacture customized orthoses using 3D printing greatly enhances patient comfort, as the design can be tailored to the user's exact anatomical specifications. Additionally, digital scanning ensures an accurate fit, reducing the discomfort often associated with standard orthotic devices.

The 3D scanning process begins with the "Sense Pro Handheld" scanner, which the user holds and moves around the hand to be scanned. Using a combination of infrared sensors and cameras, the scanner captures detailed 3D data from all angles, creating a high-resolution digital model of the hand. The user adjusts the angle and moves the scanner to ensure complete coverage. Once scanning is finished, the 3D model is processed and exported in a format compatible with 3D printing.

For the 3D printing process, the exported model is imported into slicing software connected to the Ultimaker and to the Anycubic 3D Printer. The software divides the model into layers and generates the necessary instructions for the printer. The printer then heats the PLA filament, which is fed through an extruder and deposited layer by layer to create the physical object. PLA, a biodegradable thermoplastic, is commonly used for its ease of use, low cost, and versatility. The "Anycubic 3D Printer" ensures precise layer deposition, producing a fully realized 3D object based on the scanned model. Once the printing is complete, the object is removed from the print bed and is ready for use.

This orthosis was produced using an FDM (Fused Deposition Modeling) printer, a widely known Additive Manufacturing technique, also referred to as Material Extrusion. In this process, material is selected and dispensed through an opening. For this print, PLA (polylactic acid) was chosen due to its eco-friendly properties, low cost, and ease of use. As a biocompatible material, PLA is a suitable option for medical applications, minimizing the risk of adverse reactions during prolonged contact with the skin.

RESULTS

To manufacture this orthosis, a handheld scanner, model Sense, from the brand 3D Systems, was first used. This scanner created a precise digital model of the employee's hand, capturing detailed anatomical data to ensure a perfect fit. The ability to obtain a highly accurate 3D representation of the patient's hand is a critical factor in ensuring the effectiveness of the orthosis.

Next, the obtained figure was displayed on the computer screen and refined using two software

programs, MeshMixer and MeshInspector. These programs were used to optimize the digital model by creating a mesh around the prototype, allowing for a well-structured and stable orthosis. After refining the model, the final design was prepared for 3D printing by adding necessary supports in the Ultimaker Cura software. Support structures are crucial in 3D printing, as they prevent deformation and ensure the structural integrity of the final product.

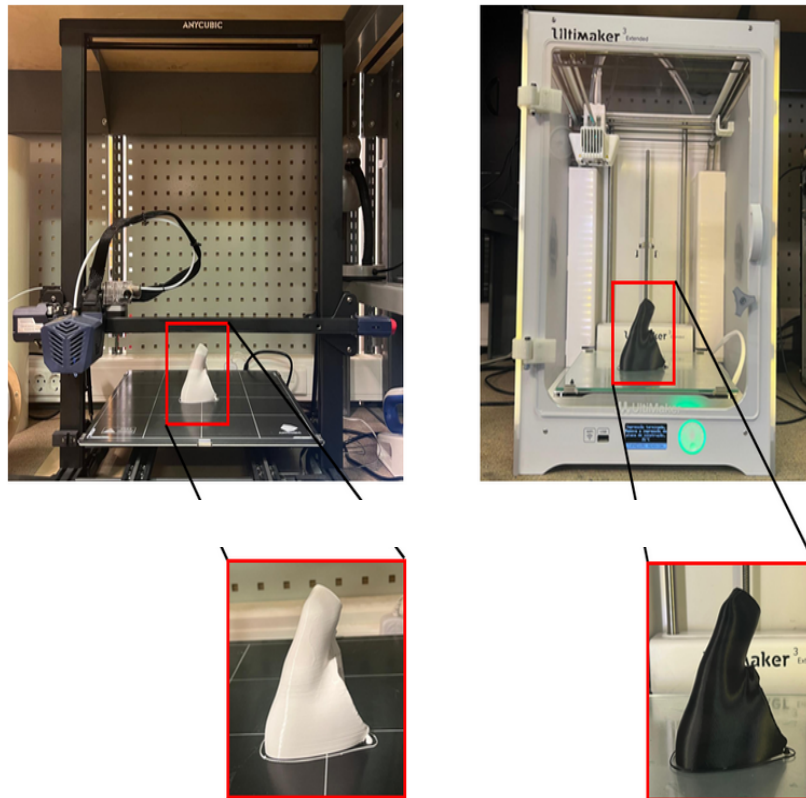

Figure 1- 3D printing of the orthosis on FDM printers.

Finally, the orthosis was printed using an FDM 3D printer, figure 1. The printer built the orthosis layer by layer, with each layer adhering precisely to the previous one, forming a lightweight yet durable device. The entire printing process was completed within a few hours, demonstrating the efficiency of 3D printing in producing customized medical devices.

CONCLUSIONS

After two months of use, the employee reported that the orthosis significantly alleviated her pain and improved her ability to perform daily activities. This positive outcome confirms the effectiveness of 3D-printed orthoses in treating musculoskeletal conditions such as De Quervain's Tenosynovitis. The ability to create custom-fit devices quickly and affordably is one of the most significant advantages of 3D printing in the medical field.

With this result, it can be stated that 3D printing technology increasingly has a positive impact on the manufacturing of objects, particularly in the healthcare sector. The study highlights how additive manufacturing enables the creation of patient-specific solutions that improve comfort and effectiveness, reducing the need for traditional, labor-intensive manufacturing methods. Moreover, the success of this project suggests that similar applications could be explored for other musculoskeletal conditions, expanding the potential of 3D printing in orthotics and prosthetics.

As 3D printing technology continues to advance, the range of materials available for medical applications will expand, further enhancing the quality and durability of printed medical devices. Future research could explore alternative materials, such as flexible polymers, that could provide additional comfort and adaptability for patients.

Additionally, integrating artificial intelligence (AI) and machine learning into the design and manufacturing process could further improve the customization and efficiency of 3D-printed medical devices. AI algorithms could analyze patient data and automatically generate optimized designs, reducing the need for manual adjustments and enhancing the precision of the final product.

In conclusion, the study demonstrates that 3D printing offers a viable, cost-effective, and highly customizable solution for medical applications. With continuous technological advancements, additive manufacturing is poised to play an even greater role in revolutionizing healthcare, making personalized treatments more accessible to patients worldwide.

REFERENCES

Additive manufacturing - General Principles. (2015). *ISO 17296-2*.

Anatomia Humana Da Locomoção. (2019). *Internet Archive*. <https://archive.org/details/anatomiahumanadalocomocao/page/n13/mode/2up>

Miraldo, L. C. (2019). Impressão 3D em Ortopedia - aplicações no presente e no futuro. *Faculdade de Medicina da Universidade de Coimbra*. <https://estudogeral.uc.pt>

Oliveira, V. P. M. D. (2023). Inovação em cirurgias de joelhos: Implementação de biomodelos 3D para preparação do processo cirúrgico (p. 52). *Instituto de Ciência e Tecnologia de Sorocaba, UNESP*. https://www.sorocaba.unesp.br/Home/Graduacao/EngenhariadeControleeAutomacao/galdenoro1906/inovacao-em-cirurgias-de-joelhos_implementacao-de-biomodelos-3d-para-preparacao-do-processo-cirurgico.pdf

Veríssimo, A. (2020). Ortóteses, quais os tipos e para que servem? *Mais Que Cuidar*. <https://www.maisquecuidar.com/ortoteses-tipos-para-que-servem>

Vista do Tenossinovite de Quervain: Estratégias para diagnóstico preciso e tratamento eficaz. (n.d.). <https://www.sevenpublicacoes.com.br/anais7/article/view/5427/9958>

Linear transformations in an engineering course – Matrices and dynamic representations

E. Cordeiro^{1*}, P.M. Barros²

¹Instituto Politécnico de Bragança, 5300-253, Bragança, Portugal

²Centro de Investigação em Educação Básica, Instituto Politécnico de Bragança, 5300-253, Bragança,

(*)**Email:** emc@ipb.pt

ABSTRACT

Several studies point to the importance of teachers creating learning environments that involve students more in the construction and communication of knowledge. On the other hand, digital technologies can be used as didactics tools to improve learning. To promote the development of skills in the area of linear algebra, more specifically in the context of linear transformations, we chose to propose an activity involving Geogebra. This software allows symbolic representations of multiple linear transformations of the plane, either through the matrix route or through its analytical expression, while also allowing the observation of the image of particular objects through this transformation. The experiment was carried out with students of an engineering course who were attending the Linear Algebra and Analytical Geometry curricular unit. The students also answered a questionnaire to evaluate their learning and assess the relevance of Geogebra in the acquisition of concepts. Their feedback shows that this software encourages creativity and promotes experimental research, having been considered an excellent ally in understanding concepts related to linear transformations and their properties.

Keywords: Geogebra, linear transformations, linear algebra, higher education.

INTRODUCTION

Linear algebra is a relevant area for the academic training of engineers (Berman & Okubo, 2015). However, according to several studies, it is a source of difficulties for many higher education students, both in terms of the prior knowledge required to follow the curricular units that focus on this area (e.g. Barros, Silva & Fernandes, 2021; Barros, Fernandes & Araújo, 2016; Uzuriaga, Arias & Manco, 2008) and in terms of the knowledge inherent to the linear algebra contents themselves (e.g. Barros, 2018; Aygor & Burhanzade, 2014; Karrer, 2006). Understanding many linear algebra concepts requires a level of abstraction that many first-year engineering undergraduate students have difficulty achieving. By enabling interactive explorations and the visualization of multiple representations, Geogebra software can contribute to a more motivating learning environment that promotes the understanding of abstract concepts and helps students overcome some of their difficulties (e.g. Cordeiro & Barros, 2023; Santos & Di Blasi, 2011; Pires & Marques, 2009; Karrer, 2006).

Considering the above assumptions, we conducted an experiment with students of a Computer Engineering degree course who were attending the Linear Algebra and Analytical Geometry course. The experiment involved solving some tasks, including constructing polygons and observing their image associated with certain linear transformations.

RESULTS

The formal concept of linear transformation was introduced by the teacher in the classroom. Students then solved a set of tasks that aimed to promote, in an evolutionary way, the understanding of the concept and its properties.

The first task was carried out with pencil and paper. Starting from the construction of the reflection of a quadrilateral $[ABCD]$ over x -axis, and then over y -axis, it was intended that students interpret the geometric representation to determine the algebraic expression that defines it and verify that it checks linearity properties for addition and scalar multiplication. For example, in the case of reflection through the x -axis, students identified the image point of each point (x, y) of the quadrilateral and recognized that $T(x, y) = (x, -y)$ is the law that defines this transformation. They also verified that the cartesian coordinates of the image of each point of the quadrilateral were written as a linear combination of the coordinates of that point.

The following tasks already included using Geogebra to evaluate the image of polygons through multiple linear transformations regarding their size, shape and angles.

With dynamic constructions like the one in Figure 1, students were able to observe that the image of an object through a linear transformation $T(x, y) = (kx, ky)$, in \mathbb{R}^2 , can present changes in size in relation to the original and maintain its main characteristics (shape and angles). At the same time, they observed that $T(x, y) = (kx, ky)$ can be represented by the scalar matrix

$$\begin{bmatrix} k & 0 \\ 0 & k \end{bmatrix}.$$

By varying the parameter k , the algebraic, matrix and graphical representations are updated, which facilitates the understanding of linear transformations whose image $[A'B'C'D'E']$ represents a homothety of the polygon $[ABCDE]$.

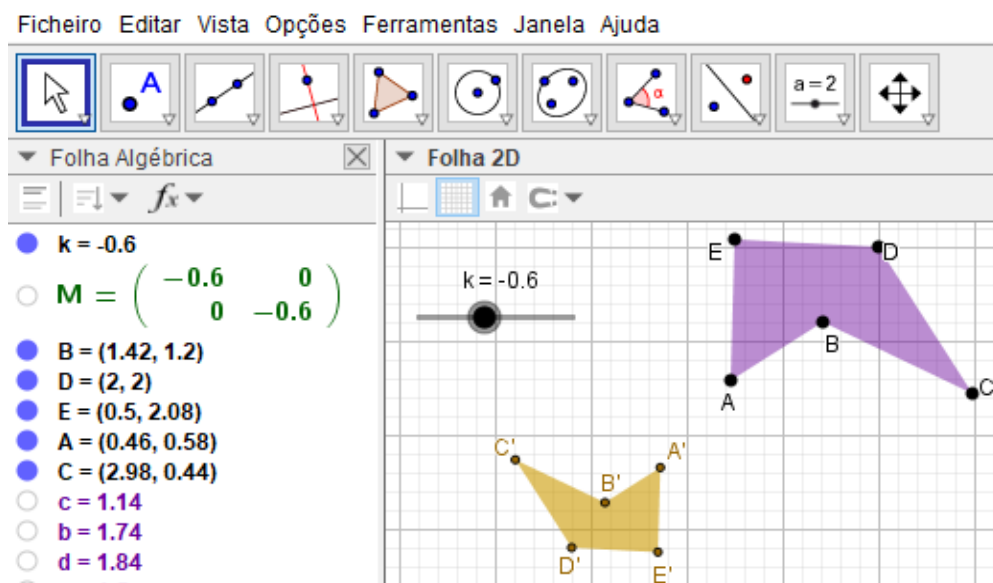

Figure 1 - Homothety.

In the last task, students were asked to apply any linear transformation to a polygon. With the help of the teacher, they built applications like the one in Figure 2, which allowed them to

understand that the square matrix of order two

$$\begin{bmatrix} a & b \\ c & d \end{bmatrix}$$

represents any linear transformation $T(x, y) = (ax + by, cx + dy)$ of \mathbb{R}^2 . By varying the values of parameters a, b, c, d , students were able to observe several linear transformations, as well as their effect when applied to a given object. The image of the polygon $[ABCDE]$ can represent similar polygons or different deformations of this object.

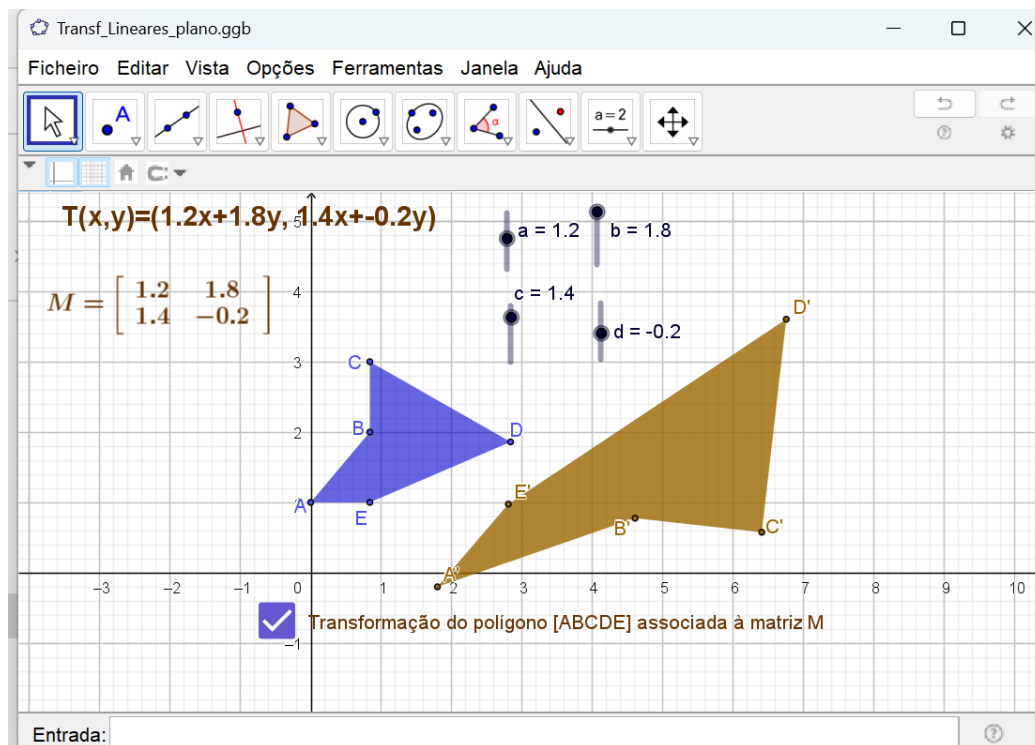

Figure 2- Deformation.

By observing algebraic and geometric representations of multiple linear transformations of the plane, students better understood the linearity properties of these functions and their relationship with the fact that the cartesian coordinates of the image of any point on the object are written as a linear combination of the coordinates of the respective point.

According to the responses to the questionnaire, given after the activity, students agree or completely agree that Geogebra allows visualizing the graphical effect of multiple linear transformations (96.1%), facilitates the identification of properties associated with them (94.1%), as well as facilitating autonomous learning (92.2%).

CONCLUSIONS

From the results obtained, we can conclude that the Geogebra software allowed students to establish connections between what they visualized and the respective concepts, which facilitated the understanding of the equivalence between the analytical and matrix definitions of a linear transformation. The students also acquired skills in Geogebra, although it was recognized that some needed more time to familiarize themselves with the software.

REFERENCES

- Aygor, N., & Burhanzade, H. (2014). The comparative analyzes of the student's performance about matrix in Student Selection Exam (ÖSS) and the Approved Lecture Books of Ministry for the National Education (MEB). *Procedia Social and Behavioral Sciences*, 136, 360-369. <https://doi.org/10.1016/j.sbspro.2014.05.342>
- Barros, P. M. (2018). O ensino e a aprendizagem de conceitos de álgebra linear no ensino superior politécnico [Tese de doutoramento, Universidade do Minho]. Repositório Institucional da Universidade do Minho. <https://hdl.handle.net/1822/56688>
- Barros, P. M., Fernandes, J. A., & Araújo, C. M. (2016). Prontidão de alunos do ensino superior para a aprendizagem da álgebra linear. *Educação Matemática Pesquisa*, 18(1), 43-59. <https://revistas.pucsp.br/index.php/emp/article/view/24489>
- Barros, P. M., Silva, F., & Fernandes, J. A. (2021). Transição secundário-superior: diagnóstico dos conhecimentos matemáticos de alunos portugueses e africanos. In C. Teixeira, V. Gonçalves, Fernandes, P. O., Rodrigues, A. S., C. Guerreiro, & L. M. Santos (Eds.), *LUSOCONF2019 - II Encontro Internacional de Língua Portuguesa e Relações Lusófonas: livro de atas* (pp. 209-220). Instituto Politécnico de Bragança. <http://hdl.handle.net/10198/19030>
- Berman, A., & Okubo, K. (2015). Issues surrounding teaching linear algebra. In S. J. Cho (Ed.), *The Proceedings of the 12th International Congress on Mathematical Education* (pp. 593-595). Springer Open. https://doi.org/10.1007/978-3-319-12688-3_65
- Cordeiro, E., & Barros, P. M. (2023). Contribuições do GeoGebra para a apreensão de conceitos relativos aos espaços vetoriais. In C. Mesquita, E. M. Silva, M. V. Pires, R. P. Lopes, & P. M. F. Vaz (Eds.), *VII Encontro Internacional de Formação na Docência: livro de atas*. Bragança (pp. 530-541). Instituto Politécnico de Bragança. <https://bibliotecadigital.ipb.pt/handle/10198/28160>
- Karrer, M. (2006). Articulação entre Álgebra Linear e Geometria: um estudo sobre as transformações lineares na perspectiva dos registros de representação semiótica [Tese de doutoramento, Pontifícia Universidade Católica de São Paulo]. <https://repositorio.pucsp.br/jspui/handle/handle/11068>
- Pires, M., & Marques, M. (2009). Integrating technologies in Linear Algebra lectures. In A. Méndez-Vilas, A. Solano Martín, J. A. Mesa González, & J. Mesa González (Eds.), *Research, Reflections and Innovations in Integrating ICT in Education* (pp. 392-396). FORMATEX.
- Santos, S., & Di Blasi, M. (2011). Sistemas de ecuaciones lineales con parámetros: un enfoque dinámico. In *Actas del I Congreso Internacional de Enseñanza de las Ciencias y la Matemática – ICIECyM, II Encuentro Nacional de Enseñanza de la Matemática – II ENEM* (pp. 290-295). Universidad Nacional del Centro de la Provincia de Buenos Aires. <https://core.ac.uk/download/pdf/328837528.pdf>
- Uzuriaga, V. L., Arias, J. J., & Manco, D. G. (2010). Algunas causas que determinan el bajo rendimiento académico en el curso de álgebra lineal. *Scientia et Technica*, 1(44), 286-291. <https://doi.org/10.22517/23447214.1849>

Awareness of sustainability practices in construction: Learning in a real context

F. Silva^{1,2,3*}, A. Santos¹, Y. Rios¹, P. M. Barros⁴

¹ESTiG, Instituto Politécnico de Bragança, 5300-253, Bragança, Portugal

²GICoS, Instituto Politécnico de Bragança, 5300-253, Bragança, Portugal

³GeoBioTec, Universidade da Beira Interior, 6201-001, Covilhã, Portugal

⁴Centro de Investigação em Educação Básica, Instituto Politécnico de Bragança, 5300-253, Bragança, Portugal

(*)**Email:** flora@ipb.pt

ABSTRACT

As part of the Higher Professional Technical Course in Civil Construction at a Polytechnic Higher Education Institution, a teaching experience was proposed in which the Technical Installations and Sustainability Practices in Construction course units were taught interconnectedly. The students mobilized the knowledge acquired in the first-course unit to carry out practical work on more sustainable solutions in buildings as part of the second-course unit. This experience allowed the students to apply their knowledge in scenarios close to their professional reality and to reflect on the complex issues of sustainability in construction.

Keywords: Hydraulics, Sustainability in construction, Higher education.

INTRODUCTION

Higher Professional Technical Courses (HPTC) are taught within the scope of Polytechnic Higher Education and include general and scientific training, technical training, and work-based training. It is important that the course units of HPTC promote, whenever possible, a greater connection to practice and that the teaching and learning contexts encourage the active involvement of students in their learning process. Silva, Barros, and Ribeiro (2018a, 2018b, 2021a) and Silva, Ribeiro, and Barros (2019, 2021b) concluded, based on experiments they carried out with HPTC students, that when learning with a strong link to practice is promoted, namely in the laboratory context, there is evidence of a positive impact on student learning.

The HPTC in Civil Construction at the School of Technology and Management (ESTiG) of the Polytechnic Institute of Bragança (Portugal) is part of the Technology training area. It includes the course units Technical Installations (Hydraulics Installations - 5 weeks) (TI) and Sustainability Practices in Construction (SPC) in its study plan. In the 2022/2023 academic year, a teaching experiment was carried out that involved teaching the two course units in an interconnected way, in which the knowledge acquired in TI was applied in SPC. The following stages were followed in this teaching experience:

- Stage 1: Preliminary study of concepts (TI);
- Stage 2: Flow measurement and proposal of efficient solutions for devices in ESTiG's sanitary facilities (SPC) (see, e.g., Silva-Afonso & Pimentel-Rodrigues, 2017);
- Stage 3: Analysis of the water network specialty of a building at the design stage (TI);

- Stage 4: Study visit to the rainwater harvesting system of the building analyzed in the project (TI);
- Stage 5: Participation in seminars and lectures on sustainable construction and research support (SPC);
- Stage 6: Study of sustainable solutions involving buildings integrated into an urban allotment (SPC) (see, e.g., Kibert, 2022).

RESULTS

The students carried out different tasks in stages throughout the process. Stage 1 covered the following content: Water distribution systems; Sewage drainage systems; Firefighting systems; Regulatory testing of building networks and applicable legislation. The knowledge gained in Stage 1 was applied in Stage 2, and a solution was proposed to replace conventional taps with efficient taps for ESTiG's sanitary facilities. Thus, the knowledge gained in the TI course unit was applied in the PSC course unit. In Stage 3, the water networks in the project were analysed, and in Stage 4, a study visit was made to the rainwater harvesting system of the building analysed in the project (Figure 1). The knowledge gained in TI was applied in PSC.



Figure 1 - Study visit to the rainwater harvesting system.

In Stage 5, students attended seminars and lectures on sustainable construction and research support. Thus, the knowledge acquired in the IT and the participation in the events allowed to apply it in the PSC. In Stage 6, sustainable solutions were studied with buildings integrated into an urban allotment, and the previously acquired knowledge was applied (Figures 2 and 3).



Figure 2 - Extract from the practical work - Phase 1.1: Rainwater harvesting system.



Figure 3- Extract from the practical work - Phase 1.4: Green roofs on buildings (role in stormwater management).

The knowledge gained throughout the experience enabled all students to complete the final task – “Points in a building where it is possible to choose more sustainable solutions”. According to student A1, “It was a task that required dedication. Coming up with valid ideas to implement in the work was stressful, but the main points were clearly explained, making the work interesting and very productive”.

As sustainability is a complex issue and students were at an early stage in their learning, some students needed help to interpret and select relevant information to complete the tasks. However, with the guidance provided by the teacher, the students were able to overcome these challenges. Student A2 said, “I had some difficulties, maybe because of the level of study we had at the time, we lacked some knowledge. However, with the explanations and guidance, we completed the activity and overcame all the obstacles.

CONCLUSIONS

The way the experience was designed allowed the students to explore the content related to sustainability practices in construction in contexts similar to those they might face in a real working environment. The link between the two curricular units and the motivational aspect also helped to complement and enrich the learning.

REFERENCES

- Kibert, C. J. (2022). *Sustainable Construction Green Building Design and Delivery* (5.^a ed.). John Wiley & Sons Inc.
- Silva, F., Barros, P. M., & Ribeiro, J. E. (2018a). Hazards and risks of machine-tools: an experience in the mechanical technology and vehicles course. In L. G. Chova, A. L. Martínez, & I.C. Torres (Eds.), *ICERI2018 - 11th International Conference of Education, Research and Innovation* (pp. 6260-6266). IATED Academy. [10.21125/iceri.2018.2474](https://doi.org/10.21125/iceri.2018.2474)
- Silva, F., Barros, P. M., & Ribeiro, J. E. (2018b). Aprender segurança e higiene: e se o nosso cenário de aula for o laboratório?. In J. B. Lopes, J. P. Cravino, & C. Costa (Eds.), *Relatos e investigação de práticas de ensino de Ciências e Tecnologia - Atas do Encontro internacional “A Voz dos Professores de C&T” (VPCT 2018)* (pp. 249-254), Universidade de Trás-os-Montes e Alto Douro. <http://hdl.handle.net/10198/18286>

Silva, F., Barros, P. M., & Ribeiro, J. E. (2021a). Interaction between course units: An experience in higher education. In L. G. Chova, A. L. Martínez, & I. C. Torres (Eds.), *ICERI2021 - 14th International Conference of Education, Research and Innovation*, (pp. 4473-4478), IATED Academy. [10.21125/iceri.2021.1031](https://doi.org/10.21125/iceri.2021.1031)

Silva, F., Ribeiro, J. E., & Barros, P. M. (2019). Aprendizagem contextualizada: cenários no ensino superior. In M. V. Pires, C. Mesquita, R. P. Lopes, E. M. Silva, G. Santos, R. Patrício, & L. Castanheira (Eds.), *IV Encontro Internacional de Formação na Docência (INCTE): Livro de atas* (pp. 982-991), Instituto Politécnico de Bragança. <http://hdl.handle.net/10198/19504>

Silva, F., Ribeiro, J. E., & Barros, P. M. (2021b). Learning exchange: a collaborative work between course units. In L. G. Chova, A. L. Martínez, & I. C. Torres (Eds.), *INTED2021 - 15th International Technology, Education and Development Conference* (pp. 9892-9898). IATED Academy. [10.21125/inted.2021.2059](https://doi.org/10.21125/inted.2021.2059)

Silva-Afonso, A., & Pimentel-Rodrigues, C. (2017). *Manual de Eficiência hídrica em Edifícios*. ANQIP.

Acoustic stimulation based on piezoelectric materials enhanced anti-proliferative activity of triple-negative breast cancer cells

A. Z. Santos¹, S. Oliveira¹, H. Dinis^{1,2}, S. Rocha^{1,3}, M. M. Fernandes^{1,2}, M. Costa^{4,5}, F. S. Silva^{1,2}, O. Carvalho^{1,2*}, V. F. Cardoso^{1,2*}

¹Center for MicroElectromechanical Systems (CMEMS-UMinho), University of Minho, Campus de Azurém, 4800-058, Guimarães, Portugal

²LABBELS-Associate Laboratory in Biotechnology and Bioengineering and Microelectromechanical Systems, Universidade do Minho, Braga/Guimarães, Portugal

³Centre for Textile Science and Technology (2C2T), Department of Textile Engineering, University of Minho, Campus de Azurém, 4800-058 Guimarães, Portugal

⁴Life and Health Sciences Research Institute (ICVS), University of Minho, Campus of Gualtar, Braga, Portugal

⁵ICVS/3B's-PT Government Associate Laboratory, Braga/Guimarães, Portugal

(*)**Email:** *oscar.carvalho@dem.uminho.pt (OC); vcardoso@cmems.uminho.pt (VFC)

ABSTRACT

Triple-negative breast cancer is highly aggressive with poor prognosis in terms of disease-free and overall survival, due to its lack of effective treatments. Hence, there is a pressing need to develop new therapies, among which ultrasound (US) stands out owing to its safety, non-invasiveness, and low cost. This work aims to develop and optimize a dynamic cell culture platform based on the application of acoustic stimuli and assess its effectiveness in reducing the proliferation of a triple-negative breast cancer cell line.

The developed system, consisting of piezoelectric ceramic actuators that were properly characterized, was tested for dynamic cell culture of highly aggressive neoplastic breast cells, the MDA-MB-231 cell line, and compared with static culture. The cellular assays revealed that US stimulation at the highest frequency tested significantly reduced metabolic activity and cell proliferation, with three daily stimulations leading to a greater reduction in cell proliferation.

Keywords: Triple-Negative Breast Cancer; Ultrasound Therapy; Dynamic Cell Culture; Piezoelectric Actuators.

INTRODUCTION

The incidence of breast cancer in women has been increasing, making it the most diagnosed cancer among women worldwide in 2020 (Sung *et al.*, 2021). Triple-negative breast cancer is particularly aggressive, with a poor prognosis, due to the lack of effective treatments (Łukasiewicz *et al.* 2021). In this regard, there is a growing interest in developing new therapies, ideally noninvasive to reduce recovery time, avoid scars and infections, and reduce the risk of recurrence. Ultrasound, a technique widely used in clinical practice, stands out given its safety, non-invasiveness, and low cost.

Ultrasound generation is based on the piezoelectric effect that indicates the conversion between electrical and mechanical energy (Zou *et al.*, 2023). Lead zirconate titanate (PZT) based ceramics remain the material of choice in many ultrasonic transducers.

Therefore, this study aims to develop and optimize a dynamic cell culture platform based on acoustic stimulation, using PZT transducers, and assess its effectiveness in reducing the proliferation of a triple-negative breast cancer cell line.

RESULTS

The results from the acoustic and thermal characterization are presented in Figure 1.

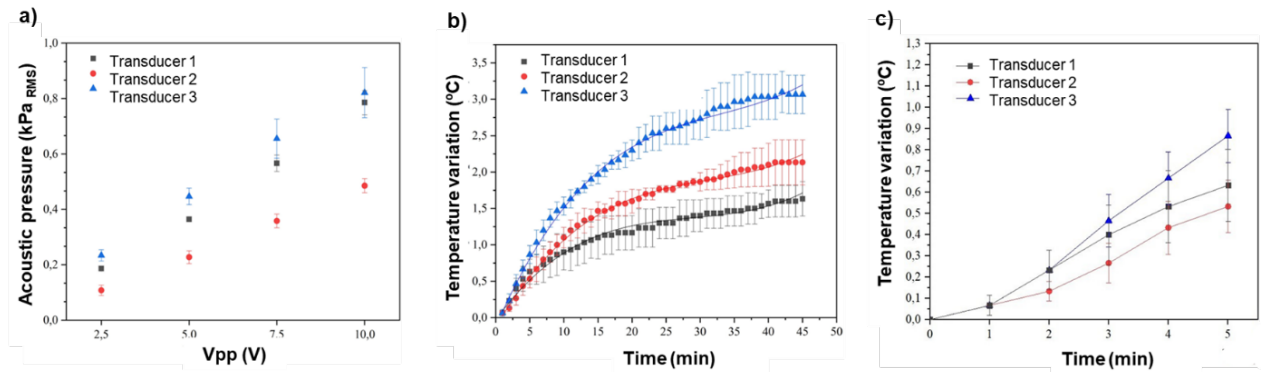

Figure 1 - a) Pressure measured in the culture well, as a function of the voltage; b) Temperature variation in the culture well, when a sinusoidal electrical signal of 10 V_{pp} is applied; c) inset of temperature variation for 5 min.

After the system had been characterized, its effects on the behavior of breast neoplastic cells were evaluated. A significant decrease in metabolic activity and cell proliferation with increasing frequency was observed, along with a reduced cell density and altered cell morphology (Figure 2). Furthermore, increasing the number of daily stimulations to three times was the most promising condition to reduce cell proliferation (Figure 3).

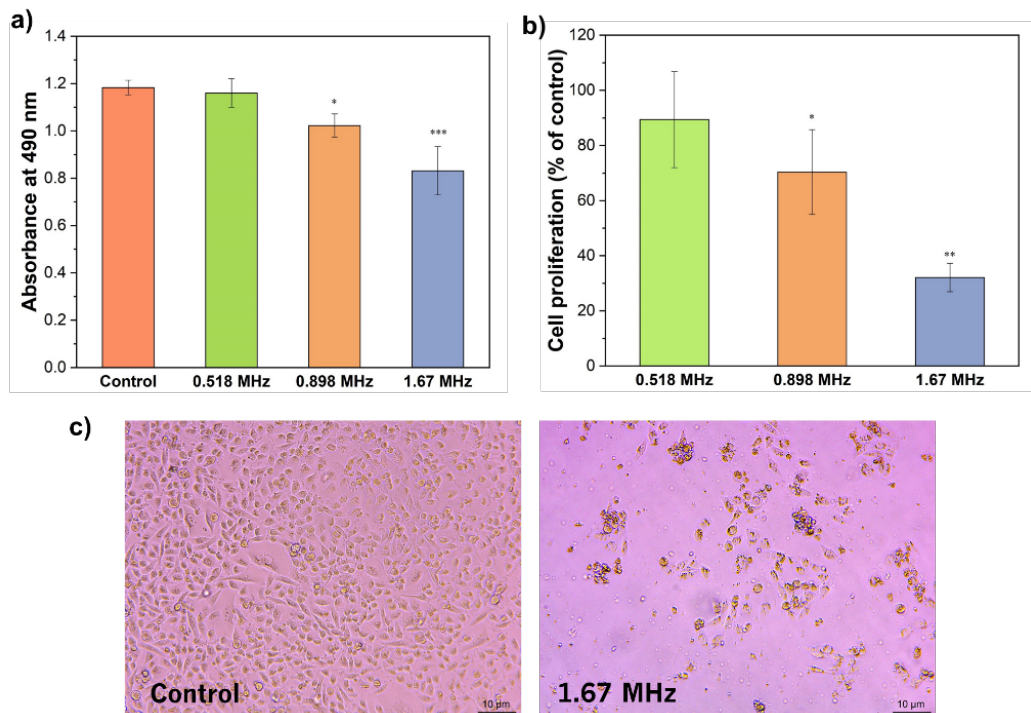

Figure 2 - Effect of US stimulation a) at different frequencies using different transducers (sinusoidal signal 10 V_{pp} for 5 min 1x) after 2 days on metabolic activity of stimulated and untreated cells (control), on b) cell proliferation, and on c) cell morphology.

Another important factor to highlight is the resistance of breast cancer cells to ultrasound stimulation with increasing cell passage number (Table 1).

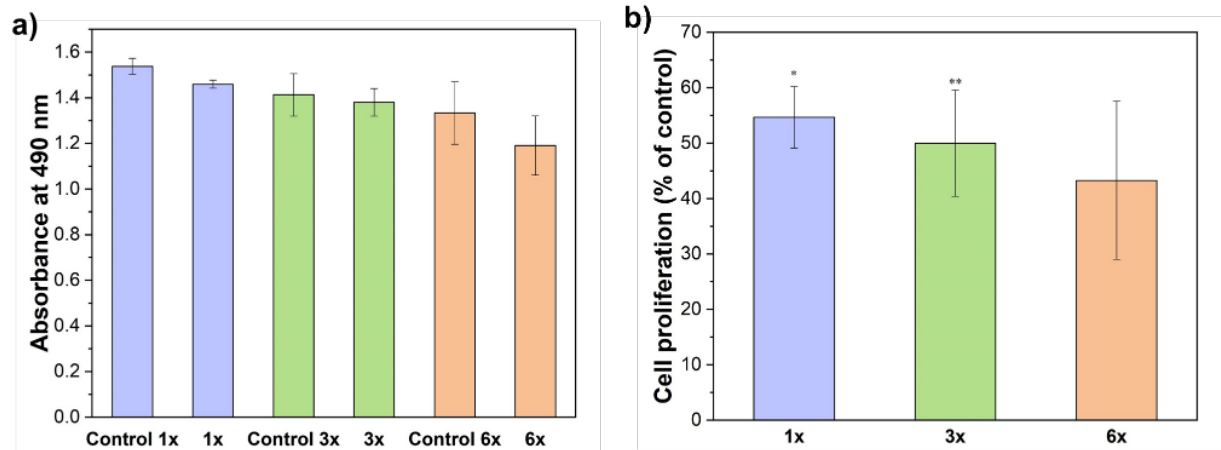

Figure 3 - Effect of ultrasound stimulation after two days on a) metabolic activity of stimulated and untreated cells (control) with ultrasound 1x, 3x and 6x a day and on b) cell proliferation.

Table 1 - Effect of cell passage number on cell proliferation.

Cell passage number	Cell proliferation (% of control)
P6	32.1±5.2
P11	54.7±5.5
P15	82.5±6.7
P16	91.4±4.4

CONCLUSIONS

By controlling the ultrasound stimulation parameters, namely the frequency and the number of daily stimulations, the metabolic activity, and the proliferation of highly aggressive and invasive breast cancer cells can be reduced.

ACKNOWLEDGMENTS

Mapping and modeling the transmission profile of optical and mechanical stimuli in the brain to optimize transcranial stimulation for combating neurological and psychiatric diseases." The reference PTDC/EME-EME/1681/2021 was assigned the DOI 10.54499/PTDC/EME-EME/1681/2021.

REFERENCES

H. Sung, J. Ferlay, R. L. Siegel, M. Laversanne, I. Soerjomataram, A. Jemal, and F. Bray. Global cancer statistics 2020: Globocan estimates of incidence and mortality worldwide for 36 cancers in 185 countries. *CA: A Cancer Journal for Clinicians*, 71(3):209–249, 2021.

S. Łukasiewicz, M. Czezelewski, A. Forma, J. Baj, R. Sitarz, and A. Stanisławek. Breast Cancer-Epidemiology, Risk Factors, Classification, Prognostic Markers, and Current Treatment Strategies-An Updated Review. *Cancers*, 13(17), 4287, 2021.

K. Zou, Q. Yue, J. Li, W. Zhang, R. Liang, and Z. Zhou. High-performance ultrasonic transducer based on PZT piezoelectric ceramic for high-temperature NDE. *Ultrasonics*, 132, 107013, 2023.

Study of the effect of the physical characteristics of bacterial nanocellulose on the proliferation of triple negative breast cancer cells

S. Rocha^{1,2,*}, C. Alves², L. Melro², A. Pereira², A. Z. Santos¹, S. Oliveira¹, V. Cardoso^{1,3}, O. Carvalho^{1,3}, J. Padrão²

¹ Center for MicroElectroMechanical Systems (CMEMS), University of Minho, Campus Azurém, 4800- 058 Guimarães, Portugal

² Centre for Textile Science and Technology (2C2T), Department of Textile Engineering, University of Minho, Campus of Azurém, 4800-058 Guimarães, Portugal

³ LBBELS – Associate Laboratory, University of Minho, 4800-058 Guimarães, Portugal

(*)**Email:** sofigrocha@gmail.com

ABSTRACT

The incidence of breast cancer, that already is the most prevalent cancer type, has been increasing. The tumor microenvironment, particularly the mechanical properties of the extracellular matrix (ECM), plays a critical role in cancer progression. This has spurred scientific efforts to create substrates capable of mimicking ECM conditions to better understand cell behavior and develop new therapies. Bacterial nanocellulose (BNC), composed of fibers with diameter within the lower range of natural ECM fibers (20-100 nm), is a promising material for such studies.

This project aims to develop *in vitro* scaffolds with varying architectures and stiffness to study their effect on the proliferation of highly aggressive human breast cancer cells (MDA- MB-231). Alginate-based structures, including microspheres, fabrics, and meshes, were created and characterized using SEM, FTIR, and TGA techniques and then added to the static culture of BNC. While BNC membranes with diverse architectures and mechanical properties were successfully produced, the cells exhibited low metabolic activity, indicating potential cytotoxicity of the developed material.

Keywords: Breast Cancer; Extracellular Matrix (ECM); Bacterial Nanocellulose (BNC); *In Vitro* Scaffolds.

INTRODUCTION

Cancer cases have a tendency to increase. Nowadays it's clear that the physical characteristics and remodelling that the stroma undergoes throughout the course of the disease are relevant to tumour progression. Thus, the study of how the different characteristics of the local microenvironment affect the cellular properties of the tumour is indispensable for understanding its response to the various therapies under development, as well as for understanding why different areas of the tumour (and different tumours) respond differently to the same treatments (Li *et al.*, 2020).

As the most abundant natural polymer on Earth, cellulose is a promising material to use as a 3D platform for cell culture. BNC stands out as a promising biomaterial since it has a three-dimensional architecture composed by nanofibres diameters in the range of 20 to 100 nm, which corresponds to the lower limit of natural ECM fibres (Luo *et al.*, 2019) ().

The aim of this project is, therefore, to evaluate the response of of neoplastic human breast

cells, MDA-MB-231, when subjected to changes in the physical properties of their substrate, namely its stiffness and architecture.

RESULTS

The modified membrane (Figure 1) clearly shows greater superficial roughness, which is due to the presence of porogens during bacterial culture. There is also a large 'crack' in the cross-section, which is also assumed to be the pore generated by the microspheres. In addition, it can also be seen that the alginate spheres have been completely eliminated (there is no evidence of their presence in the images), so it can be concluded that the porogen integration technique chosen to obtain modified scaffolds is viable.

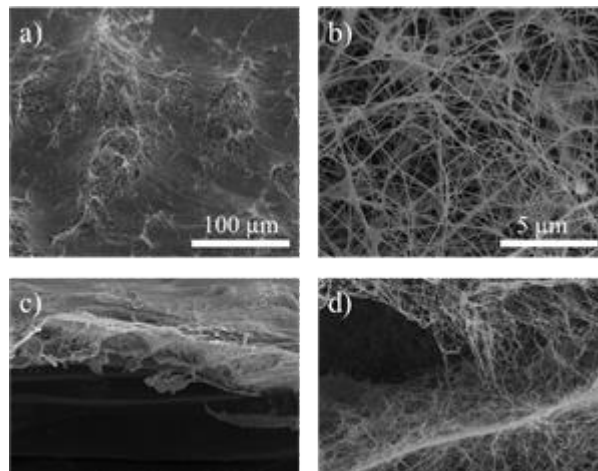

Figure 1 - Representative images of the architecture of the modified BNC membrane. a) Image of the membrane surface at 1000 X magnification; b) Image of the membrane surface at 15000 X magnification; c) Image of the cross-section made of the membrane at 5000 X magnification.

The modified scaffolds show slightly higher contact angles than the BNC-P samples (pure sample), although still typical of hydrophilic surfaces (Figure 2). From the data obtained from the graph in Figure 3, it can also be concluded that the insertion of alginate structures during the production of BNC results in a decrease in its Young's modulus.

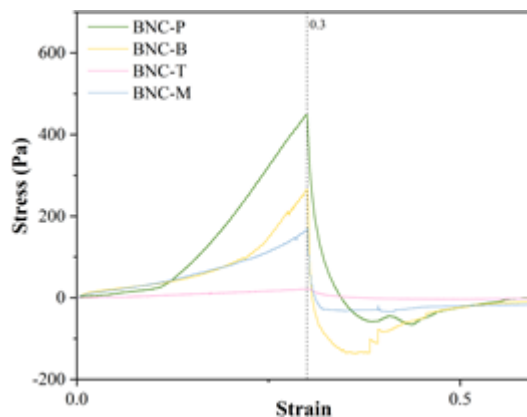

Figure 2 - Graph representing the curves obtained from the compression test carried out on the different BNC membranes produced. The vertical line indicates the moment when the force was applied.

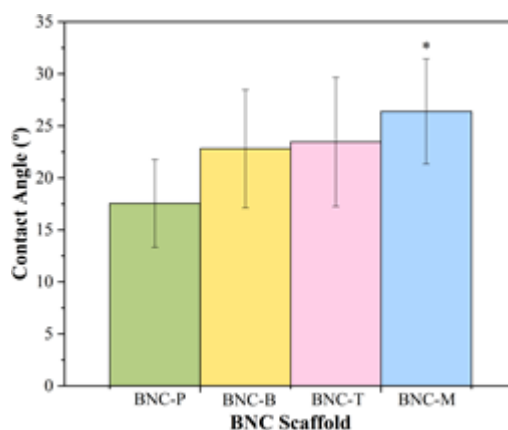

Figure 3 - Graph of the contact angle measurements obtained for the different types of BNC membranes under study. * denotes a statistically significant difference.

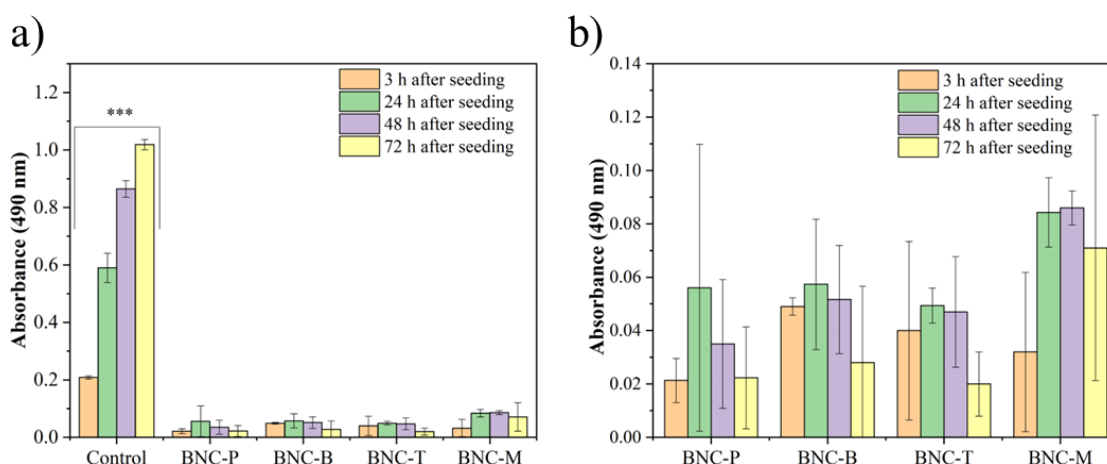

Figure 4 - Cell metabolic activity at the four timepoints analysed: a) Including cell culture directly in a well (Control); b) Only cells cultured on BNC scaffolds. * Represents a statistically significant difference.

Figure 4a) shows that there is a statistically significant difference ($p < 0.001$) between the metabolic activity of the cells grown in the control wells and those grown in the modified BNC samples. Besides, there was a decrease in absorbance from the second to the third timepoint for the samples of BNC, which may suggest a certain cytotoxicity associated with the chosen material. Other articles in which this material was developed from the same bacterial strain, reports similar problems. On the other hand, the literature associated with the development of BNC membranes from other prove that this material is viable as a cell culture platform. It is therefore assumed that these cytotoxicity problems are associated with the bacterial strain chosen.

CONCLUSIONS

Alginate shown itself as an extremely interesting material to explore and has proved suitable for producing different structures. It was also possible to conclude that the insertion of alginate structures during static culture allowed only the physical properties of the BNC scaffolds to be

altered. Finally, the strain chosen was not the most suitable for cell culture, showing cytotoxic behaviour.

ACKNOWLEDGMENTS

The project "Mapeamento e modelação do perfil de transmissão de estímulos óticos e mecânicos no cérebro para otimizar a estimulação transcraniana para combater doenças neurológicas e psiquiátricas." with the reference PTDC/EME-EME/1681/2021 is acknowledged.

REFERENCES

- N. T. Li, I. L. Co, N. Landon-Brace, S. Latour, and A. P McGuigan. Tissue-engineered 3d cancer microenvironment for screening therapeutics. *Biomaterials for 3D Tumor Modeling*, pages 453-479, 2020.
- H. Luo, T. Cui, D. Gan, M. Gama, Q. Zhang, and Y. Wan. Fabrication of a novel hierarchical fibrous scaffold for breast cancer cell culture. *Polymer Testing*, 80:106107, 2019.
- M. Ugrin, J. Dinic, S. Jeremic, S. Dragicevic, B. Banovic Djeri, and A. Nikolic. Bacterial nanocellulose as a scaffold for in vitro cell migration assay. *Nanomaterials (Basel, Switzerland)*, 11(9):2322, 2021.

Collaborative work between Polytechnic Higher Education students: Manufacturing processes, Safety and Sustainability

F. Silva^{1,2,3*}, J. E. Ribeiro^{4,5}, P. M. Barros⁶

¹ESTiG, Instituto Politécnico de Bragança, 5300-253, Bragança, Portugal

²GICoS, Instituto Politécnico de Bragança, 5300-253, Bragança, Portugal

³GeoBioTec, Universidade da Beira Interior, 6201-001, Covilhã, Portugal

⁴Centro de Investigação de Montanha (CIMO), Instituto Politécnico de Bragança, 5300-253, Bragança, Portugal

⁵Laboratório Associado para a Sustentabilidade e Tecnologia em Regiões de Montanha (SusTEC), Instituto Politécnico de Bragança, 5300-253, Bragança, Portugal

⁶Centro de Investigação em Educação Básica, Instituto Politécnico de Bragança, 5300-253, Bragança, Portugal

(*)**Email:** flora@ipb.pt

ABSTRACT

The link with the real working environment, combined with the sharing of knowledge and collaboration between students from different courses, was the basis of a teaching experience involving students from the Mechanical Technology I course unit of the Mechanical Engineering degree course and the Safety and Environment course unit of the Higher Professional Technical Course in Sustainable Technologies in Mechanics and Vehicles, at a Polytechnic Higher Education Institution in the north of Portugal. The final objective was to carry out collaborative work on metalworking processes, the safety at work related to these processes, and waste management.

Keywords: Collaborative work, mechanics, safety, environment, higher education.

INTRODUCTION

In Higher Education, at least since the Bologna process, teachers have been challenged to promote students' autonomy and to help them assume the role of protagonists in the teaching-learning process (Caballero & Bolívar, 2015). Barbosa and Moura (2013) believe that active learning occurs when students interact with the subject under study - listening, speaking, questioning, discussing, doing, and teaching - and are encouraged to construct knowledge rather than passively receiving it from the teacher.

Adding to these assumptions the importance of students experiencing difficulties in an environment that is as close as possible to the professional reality of the course they are taking (Mendes, 2015; Silva, Ribeiro & Barros, 2019, 2021, 2022), a teaching experience was implemented that focused on collaborative work between students at different levels of their academic journey. One group was taking the Mechanical Technology I course unit as part of the Mechanical Engineering degree course, and the other was taking the Safety and Environment course unit as part of the Higher Professional Technical Course in Sustainable Technologies in Mechanics and Vehicles at the School of Technology and Management of the Polytechnic Institute of Bragança.

The work was carried out in groups, including students from both courses and concerned metalworking processes, the safety at work associated with these processes, and waste management. In this way, the students played the role of “experts” in their field, contributing to the work with the knowledge acquired in their respective course units and generating knowledge together (see, e.g., Rao, 2016; Aronson, 2000; Matias, Masulck & Schneider, 2020). A study visit to a foundry and a seminar on sustainability in the metalworking industry with students from both courses further supported this.

RESULTS

Once the collaborative work was completed, the students presented it to their colleagues. This process took place in two stages, as each group produced two pieces of work, and the topics for the second piece of work were not assigned until after the first presentation session.

This division into two stages was based on the content of Mechanical Technology I, which aims to help students acquire knowledge of two major groups of metalworking processes. Thus, in Stage I, the topics assigned were related to casting manufacturing processes, and in Stage II, to metal plastic forming manufacturing processes.

Figures 1-(a) and (b) show some extracts from the work produced for each stage.

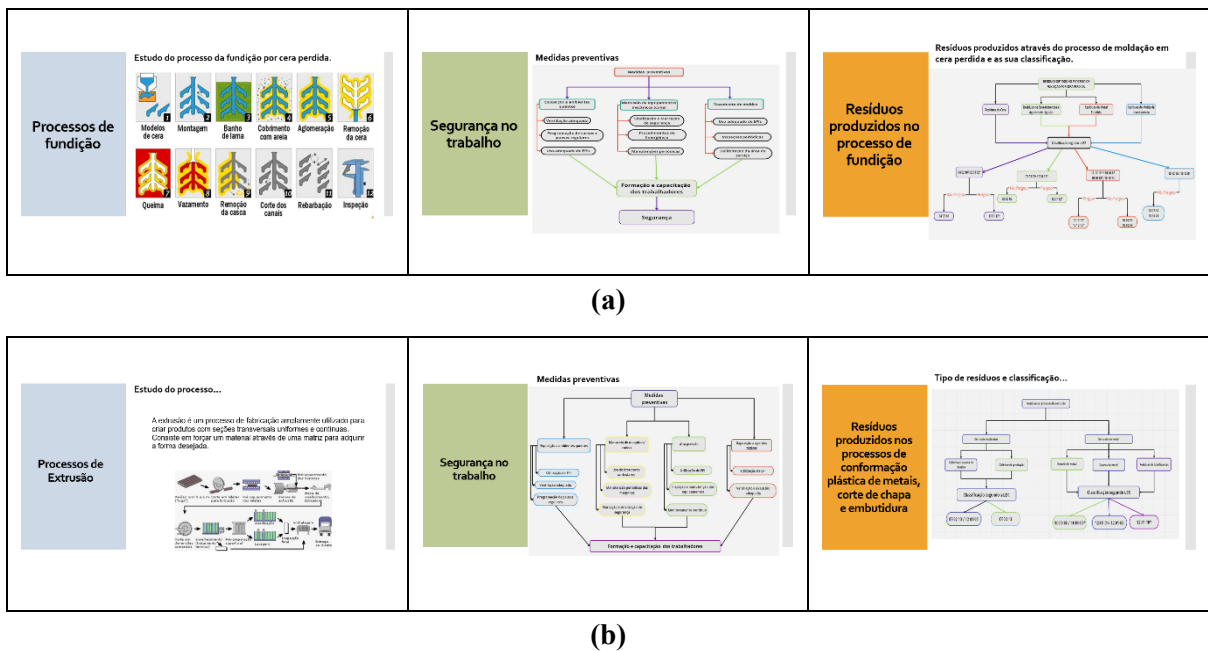

Figure 1 - Extract of work from stage 1 (a) and 2 (b).

Regardless of the topic or process being studied, the work followed a similar structure at each stage, as shown in Figure 1. First, the students presented a brief description of the process related to their topic. Next, they analyzed the hazards, risks, and preventive measures associated with the process. Finally, they analysed the types of waste produced, their classification, and explored possible methods of reduction or reuse depending on the context.

All the groups completed their work and addressed all the necessary components, although the depth of the descriptions and analyses varied among the groups.

Based on their status as participant observers (Gómez, Flores & Jiménez, 1999), the class teachers noted initial difficulties developing collaborative work in some groups. Students tended to work only with the students on their course, trying to develop the part most directly related to their course unit. However, the proposed work involved linking the different components, which meant that students had to make an effort to collaborate more actively and to debate opinions to achieve the planned objectives.

Therefore, to make the learning more meaningful, after the first assignments had been completed and presented, the students were asked for possible suggestions to improve the second-stage assignments, and the suggestions were discussed in class.

In addition to suggestions for enhancing the theoretical aspects of the work and making the presentation materials more appealing and organized, this debate sparked a discussion about the attitudes and behaviors of both presenters and the audience during presentations. As a result, it was decided that it would be more motivating and beneficial for the students themselves to moderate the second presentation session.

CONCLUSIONS

Reflecting on the difficulties and discussing suggestions for improvement in the realization and presentation of the work played an important role in the student's performance in the second assignment. We believe that this type of experience is always beneficial for students, both in terms of building knowledge and developing transversal skills, such as the ability to communicate and collaborate with peers: "It was an enriching experience, working in a group made me improve my team spirit as well as my presentation skills"; "I think it was a positive experience that enriched our knowledge and taught us how to collaborate between classes".

REFERENCES

- Aronson, E (2000). Nobody left to hate developing the emphatic school room. *The Humanist*, 60, 17-21.
- Barbosa, E. F. & Moura, D. G. (2013). Metodologías ativas de aprendizagem na educação profissional e tecnológica. *Boletim Técnico do Senac*, 39(2), 48-67. <https://doi.org/10.26849/bts.v39i2.349>
- Caballero, K., & Bolívar, A. (2015). El profesorado universitario como docente: hacia una identidad profesional que integre docência e investigación. *Revista de Docencia Universitaria*, 13(1), 57-77. <https://doi.org/10.4995/redu.2015.6446>
- Gómez, G. R., Flores, J. G., & Jiménez, E. G. (1999). *Metodología de la investigación cualitativa* (2.ª ed.). Ediciones Aljibe, S. L.
- Matias, M. A. D. F. B., Masulck, R. D., & Schneider, S. G. (2020). Método jigsaw classroom: aprendizagem cooperativa no ensino superior tecnológico. *Revista CBTECLE*, 4(1), 209-223. <https://revista.cbtecle.com.br/index.php/CBTECLE/article/view/257>
- Mendes, J. (2015). O papel da formação em Segurança e Saúde no Trabalho no desenvolvimento de competências profissionais: estudo de caso [Dissertação de Mestrado, Instituto Politécnico de Setúbal]. <http://hdl.handle.net/10400.26/10520>

Rao, V. D. (2016). Understanding jigsaw cooperative learning: Influence on scholastic achievement and learning experiences of students in mathematics education. *The International Journal of Indian Psychology*, 3(3), 100-106.

Silva, F., Ribeiro, J. E., & Barros, P. M. (2019). Aprendizagem contextualizada: cenários no ensino superior. In M. V. Pires, C. Mesquita, R. P. Lopes, E. M. Silva, G. Santos, R. Patrício, & L. Castanheira (Eds.), *IV Encontro Internacional de Formação na Docência (INCTE): Livro de atas* (pp. 982-991), Instituto Politécnico de Bragança. <http://hdl.handle.net/10198/19504>

Silva, F., Ribeiro, J. E., & Barros, P. M. (2021). Learning exchange: a collaborative work between course units. In L. G. Chova, A. L. Martínez, & I. C. Torres (Eds.), *INTED2021 - 15th International Technology, Education and Development Conference* (pp. 9892-9898). IATED Academy. <https://doi.org/10.21125/inted.2021.2059>

Silva, F., Ribeiro, J. E., & Barros, P. M. (2022). Learning scenarios in safety at work in the scope of Polytechnic higher education courses. In L. G. Chova, A. L. Martínez, & I. C. Torres (Eds.), *ICERI2022 - 15th Annual International Conference of Education, Research and Innovation* (pp. 9892-9898). IATED Academy. <https://doi.org/10.21125/inted.2021.2059>

Learning linear algebra with the MathE platform: an experience in a Mechanical Engineering course

P. M. Barros^{1*}, E. Cordeiro², F. Silva^{2,3,4}

¹ Centro de Investigação em Educação Básica, Instituto Politécnico de Bragança, 5300-253, Bragança, Portugal

² ESTiG, Instituto Politécnico de Bragança, 5300-253, Bragança, Portugal

³ GICoS, Instituto Politécnico de Bragança, 5300-253, Bragança, Portugal

⁴ GeoBioTec, Universidade da Beira Interior, 6201-001, Covilhã, Portugal

(*)*Email:* pbarros@ipb.pt

ABSTRACT

Linear algebra is part of the curriculum of most engineering courses. However, many students' difficulties in this area and the heterogeneity of their mathematical knowledge pose significant challenges for teachers. In this context, more personalized and interactive learning is needed to help overcome individual difficulties and promote autonomy in constructing knowledge. Technological platforms such as MathE are important tools in this process, as they facilitate the development of skills in searching, selecting, and analyzing the information provided. Therefore, as part of the Linear Algebra and Analytical Geometry course unit of a Mechanical Engineering degree course, we proposed that students use the Self Need Assessment component of the MathE platform to take two tests: one at a basic level and the other at an advanced level on the topics of Vector Spaces (VS) and Linear Transformations (LT). After submitting each test consisting of seven multiple-choice questions, the students were asked how they had performed. We also asked them to present their solutions to get them to identify and correct their own mistakes based on the feedback provided by the platform and the teacher. When complemented with other approaches, the MathE platform can be a valuable tool to increase students' autonomy in overcoming their difficulties, thus promoting the learning of linear algebra.

Keywords: Linear algebra, MathE platform, higher education

INTRODUCTION

The massification of higher education in Portugal, and more recently, the increase in students from other countries, has led to a significant heterogeneity in their mathematics education. On the other hand, the assumptions of Bologna imply that student autonomy should be promoted, with students assuming the role of protagonists in the teaching-learning process (Caballero & Bolívar, 2015; Lima, Menezes & Carregã, 2016). All of this poses a challenge for higher education teachers to propose tasks that promote self-regulation of learning, lead students to work autonomously and develop the ability to identify and correct their mistakes to overcome difficulties (Barros, 2018). The MathE platform (<https://mathe.pixel-online.org>), designed to enrich the mathematics learning experience in higher education, can help achieve these goals. It provides students free access to various resources, such as video collections, teaching materials, and self-assessment questions on specific areas of mathematics (Pereira et al., 2020).

Given the learning difficulties of engineering students in linear algebra, frequently identified by the authors in the classroom context and referred to by various authors (Barros, 2018; Karrer, 2006; Andreoli, 2005; Dorier & Sierpinska, 2001; Hillel, 2000), we proposed to explore the potential of the Self Need Assessment feature of the MathE platform, to serve as self-regulation of study for the summative assessment test and promote assessment for learning. The experiment was conducted with mechanical engineering students enrolled in the Linear Algebra and Analytical Geometry course unit and evaluated using a questionnaire.

RESULTS

In the Self Need Assessment component of the MathE platform, it is possible to select the subtopic for which you want to carry out the assessment within each mathematics domain. Particularly, in the case of linear algebra, one can choose between the subtopics: Matrices and determinants, Linear systems, Eigenvalues and eigenvectors, Linear transformations and Vector Spaces. In the case of the present study, it was proposed that students take a basic-level test and another at an advanced level on the last two topics. The basic level test was carried out outside class and individually. The advanced-level test was carried out in groups and in the classroom. In the case of multiple-choice tests, the aim was for students to reformulate their solutions according to the feedback provided by the platform. In this sense, students were asked to submit their latest resolutions after consulting material or watching videos suggested by the platform to correct incorrect answers. This allowed them to reflect on their reasoning, grasp new concepts, identify their mistakes and overcome difficulties. Therefore, in addition to assessing learning, it was intended that solving tests would also have a formative role.

Figure 1 presents an example of a question about Vector Spaces, which appeared in the advanced level test of a group of students.

Topic: Linear Algebra**Subtopic:** Vector Spaces

Consider the subspaces of \mathbb{R}^3 , S_1 generated by $A = \{(1, 0, -3), (1, 5, 7), (3, 5, 1)\}$ and $S_2 = \{(x, y, z) : x + 2y = 0\}$. The vector space $S_1 \cap S_2$ is:

- $\{(-2y, y, 8y) : y \in \mathbb{R}\}$
- $\{(2y, y, z) : y, z \in \mathbb{R}\}$
- $\{(x, y, 3y) : y \in \mathbb{R}\}$
- $\{(2y, y, 6y) : y \in \mathbb{R}\}$
- I don't know

Figure 1 – Advanced level test question about Vector Spaces.

Figure 2 presents an extract of the final resolution that the group of students submitted. Although they did not formally write the expression, it seems that they started by trying to identify the subspace S_1 generated by the set A,

$$S_1 = \{(x, y, z) \in \mathbb{R}^3: (x, y, z) = k_1(1, 0, -3) + k_2(1, 5, 7) + k_3(3, 5, 1)\},$$

having concluded that $S_1 = \{(x, y, z) \in \mathbb{R}^3: 3x - 2y + z = 0\}$.

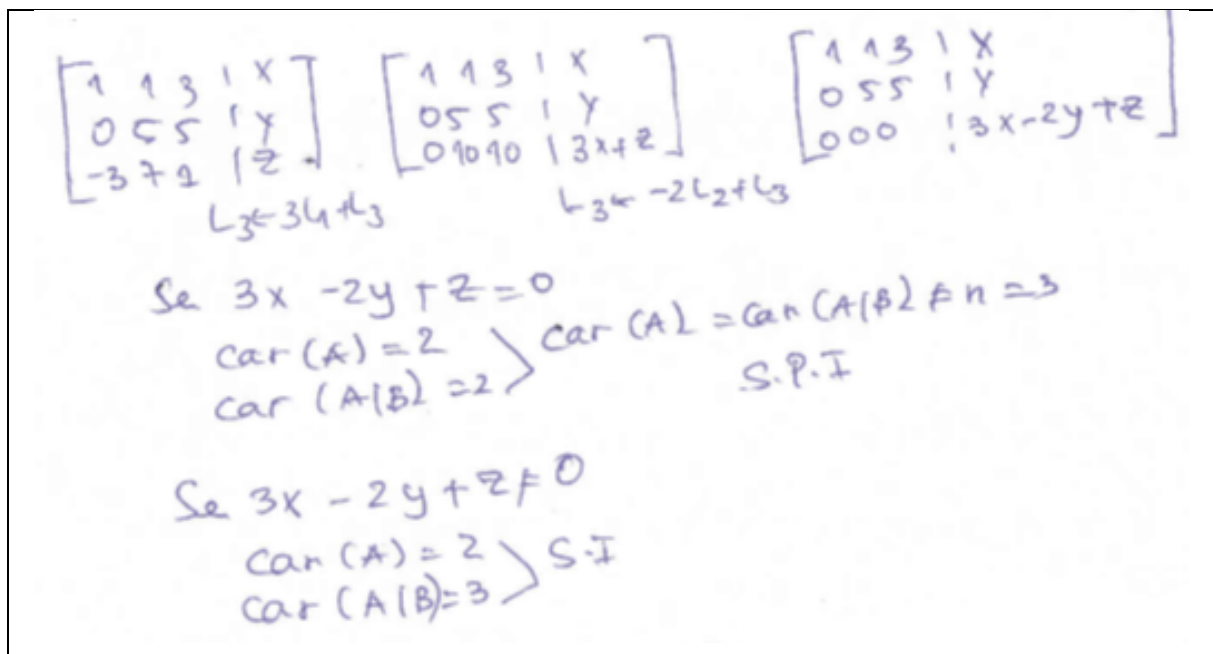

Figure 2 – Extract from the resolution of the question in Figure 2 by a group of students.

Following this resolution, the students solved the system of linear equations

$$\begin{cases} 3x - 2y + z = 0 \\ x + 2y = 0 \end{cases}$$

to find its solution set, which would correspond to the space vector resulting from the intersection of S_1 e S_2 . They appropriately concluded that the correct answer was the first option in the statement, that is, $\{(-2y, y, 8y): y \in \mathbb{R}\}$ (see Figure 2).

The students' opinions about the experience were obtained from their answers to the questionnaire. According to the results obtained, the majority of the students said that they discussed the solution of the questions with their classmates, even the basic level questions that were solved outside of class (69.2% - VS and 76.9% - LT, in the basic level tests; 76.9% - VS and 69.2% - TL, in the advanced level tests). We also found that more than 70% of the students agreed or strongly agreed that solving the questions was very difficult (76.9% - EV and 80.8% - TL in the basic level tests; 73.1% - EV and 76.9% - TL in the advanced level tests), which was also observed by the teacher when monitoring the students.

It should be noted that this experiment was carried out when the platform did not have some of the resources (Video Collection or Teaching Material) that are currently proposed for solving questions where the chosen answer is incorrect. Although the platform's resources were

insufficient to clarify mathematical concepts or procedures, the students had the teacher's help for the tests carried out in class.

Despite the challenges, the students' feedback on the MathE platform as a support tool for the Linear Algebra and Analytical Geometry course unit is favorable. More than 85% of the students agree or strongly agree that the platform is an invaluable asset for learning (96.2%), a crucial tool for individual study (100%), and a means to identify and learn from mistakes (92.3%). The platform also motivates them to persist in solving questions they got wrong, as they can see the correct options.

CONCLUSIONS

The MathE platform, when integrated with teaching strategies that engage students in their learning, as seen in this study, can be an important tool in combating the failure of linear algebra in higher education.

REFERENCES

- Andreoli D. I. (2005). Construcción de los conceptos de dependencia e independencia lineal de vectores en alumnos de primer año de la universidad (Tercera fase). In *Comunicações Científicas y Tecnológicas*. Universidade Nacional del Nordeste. <http://host140.200-45-54.telecom.net.ar/unnevieja/Web/cyt/com2005/9-Educacion/D-004.pdf>
- Barros, P. M. (2018). *O ensino e a aprendizagem de conceitos de álgebra linear no ensino superior politécnico* [Tese de doutoramento, Universidade do Minho]. Repositório Institucional da Universidade do Minho. <https://hdl.handle.net/1822/56688>
- Caballero, K., & Bolívar, A. (2015). El profesorado universitario como docente: hacia una identidad profesional que integre docência e investigación. *Revista de Docencia Universitaria*, 13(1), 57-77. <https://doi.org/10.4995/redu.2015.6446>
- Dorier, J-L., & Sierpinska, A. (2001). Research into the teaching and learning of linear algebra. In D. Holton (Ed.), *The teaching and learning of mathematics at university level* (pp.255-273). Springer.
- Hillel, J. (2000). Modes of description and the problem of representation in linear algebra. In J-L. Dorier (Ed.), *On the teaching of linear algebra* (pp. 191-207). Springer.
- Karrer, M. (2006). *Articulação entre Álgebra Linear e Geometria: um estudo sobre as transformações lineares na perspectiva dos registros de representação semiótica* [Tese de doutoramento, Pontifícia Universidade Católica de São Paulo]. <https://repositorio.pucsp.br/jspui/handle/handle/11068>
- Pereira, A. I., Fernandes, F. P., Pacheco, M. F., Barros, P. M., Cordeiro, E., Silva, F., Geraldés, Vaz, C. B., Barros, E., Barbedo, I., Almeida, J. P., Martins, C., & Pires, M. V. (2020). Developing tools for the e-learning platform mathE. In *10th International Conference The Future of Education*. Libreriauniversitaria. it. <http://hdl.handle.net/10198/27032>
- Lima, M. L., Menezes, I & Carregã L. (2016). O ensino superior como um espaço de formação multifacetado. In M.V. Garrido and M. Prada (Coord.), *Manual de competências académicas: Da adaptação à universidade à excelência académica* (pp. 69-84). Sílabo.

Enhancing Realism in 3D Mapping Through Drone-Based Photogrammetry and Animated Elements

L. D. Deusdado¹, A. F. A. Martins¹, J. Rocha¹

¹Instituto Politécnico de Bragança, 5300-253, Bragança, Portugal

(*)**Email:** leodeus@ipb.pt, a47329@alunos.ipb.pt, jrocha@ipb.pt

ABSTRACT

Over time, society has increasingly adopted technology across various sectors and at different levels. Technological advancements have enabled the substitution of traditional models with animated 3D representations that offer higher levels of realism. This study explores the integration of drone-based photogrammetry with 3D modeling and animation techniques to produce realistic representations of outdoor environments, mapping the IPB-ESTIG campus, highlighting the integration of drones, software tools like Unity, and animation techniques for creating immersive environments. The objective was to provide a dynamic representation of the campus using photogrammetric methods and incorporating animated elements such as people and birds, allowing users to interact with the simulated environment. The challenges, methods, and results of this project demonstrate the viability of integrating photogrammetry, modeling, and animation to develop realistic 3D campus models and a more immersive experience in applications like urban planning, architecture, and environmental monitoring.

Keywords: Drone Photogrammetry; 3D Modeling; Animation Techniques; Immersive Environments.

INTRODUCTION

The use of 3D modeling and virtual reality (VR) technologies has revolutionized fields such as topography, architecture, agriculture, and environmental, ranging too, from urban planning to virtual simulations [1]. One of the more advanced techniques to achieve this is aerial photogrammetry, which uses aerial images to create detailed 3D representations of terrains and structures. Aerial photogrammetry has advanced with the advent of drones, allowing for more precise and cost-effective data collection [2]. This paper explores the development of a 3D VR model of the ESTIG campus, captured using drone technology, and examines the methods used to animate and render these models in real-time environments, enhancing the realism of such models by adding animated elements using Unity, thereby increasing the model's practical applications.

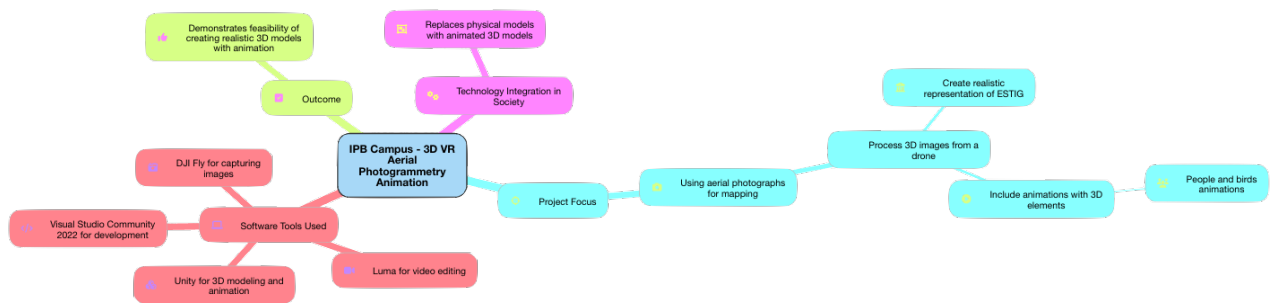

Figure 1 - Mind Map of the Process.

The goal of this work is to not only provide accurate 3D maps but also to integrate animated 3D elements such as people and birds to simulate real-world conditions more effectively.

OVERVIEW OF AERIAL PHOTOGRAMMETRY

Aerial photogrammetry involves capturing multiple aerial images at different angles to create detailed 3D models. Drones have become key tools for this technique, allowing for high-resolution mapping and data collection over large areas. Drones like the DJI Mini-series offer several advantages, such as speed, flexibility, and cost-efficiency, compared to traditional manned aerial surveys [3][4].

The ability of drones to capture 4K video and high-resolution still images allow for high-accuracy 3D reconstructions. This has made drones essential tools in fields such as civil engineering, environmental monitoring, and architecture [5]. However, drone-based aerial photogrammetry also faces challenges, such as weather dependency and limited battery life, which affect data collection efforts [6].

TOOLS AND TECHNOLOGIES

The DJI Mini 2 was used in this research to capture the aerial images necessary for developing the 3D model. This lightweight drone features a high-resolution 12 MP camera and a gimbal for stable, 4K video recording, allowing for smooth captures even in windy conditions [7]. It also offers intelligent flight modes, including QuickShots and Panorama, which streamline the process of image and video capture [8].

For processing the aerial images, the Software Luma Capture tool was employed. Luma allows for the conversion of drone images into 3D models using photogrammetry algorithms that reconstruct surfaces based on multiple perspectives [9]. The Luma AI engine also refines the texture and geometry of the 3D models, ensuring a high degree of realism in the final render [10].

To optimize the workflow, the project also utilized Unity for animation and Blender for 3D model editing. Unity's NavMesh feature was used to automate the movement of 3D elements such as pedestrians and birds within the VR environment [11].

METHODOLOGY

The first step involved flying the DJI Mini 2 over the ESTIG campus to collect aerial images. The images were captured in clear weather to ensure optimal lighting and visibility conditions. The drone was flown using the DJI Fly app, which offers intuitive control over flight paths and camera settings [12]. The images were saved on a high-speed SD card to ensure smooth recording of 4K video at 30 frames per second (FPS).

Once the data was collected, the images were processed in Luma Software to generate a 3D map. The Luma AI engine used photogrammetry techniques to analyze the spatial relationships between the images and recreate a detailed 3D model [13]. Textures from the images were applied to the model, providing a realistic depiction of the ESTIG campus, as Figure 2 displays.

The 3D model was exported from Luma in OBJ format, which is compatible with Unity for further processing and animation. Due to the size of the model, a medium-polygon version was selected to balance quality and performance [14].

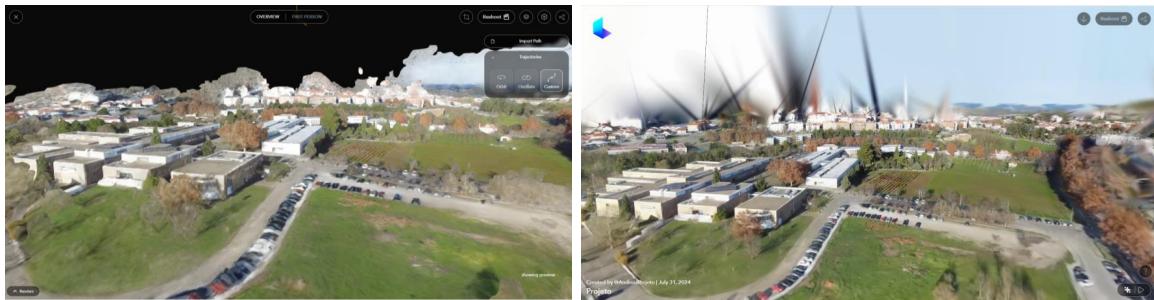

Figure 2 - Obj Model vs Gaussian Splat model.

To enhance the realism of the model, animated elements were added using Unity. Pedestrians and birds were introduced into the virtual environment using NavMesh, which enables automated movement along predefined paths [15]. This approach allows for realistic interaction between the 3D models and the environment, simulating real-world behaviour such as walking or flying [16].

CHALLENGES AND SOLUTIONS

One of the primary challenges in drone-based photogrammetry is the dependence on weather conditions. Drones require stable weather with minimal wind to capture high-quality images. During this project, several flight attempts were postponed due to rain and high wind speeds [17]. A clear, sunny day was eventually selected to ensure proper lighting for the images.

Processing large 3D models can be resource-intensive, particularly when dealing with high-polygon models. To avoid performance degradation during the testing phase, a medium-polygon version of the 3D model was selected. This reduced the file size without sacrificing too much visual quality [18] (Figure 3).

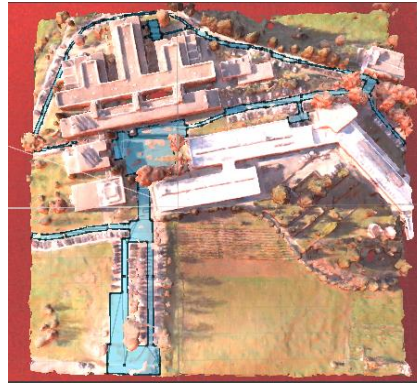

Figure 3 - Path Walk movement in low model.

Additionally, the introduction of animated elements posed performance challenges. The use of object pooling helped manage resource allocation by reusing inactive objects, such as pedestrians, instead of creating and destroying them continuously [19].

OPTIMIZATION TECHNIQUES

To optimize the performance of the animated elements, an object pooling technique was employed. This technique involves maintaining a pool of inactive objects that can be reactivated as needed, reducing the overhead associated with object creation and destruction [20]. For example, pedestrians who exit the scene are not destroyed but returned to the pool, ready to be reused when a new pedestrian is introduced [21].

To further optimize rendering performance, occlusion culling was implemented. This technique ensures that only objects visible to the camera are rendered, reducing the computational load when navigating through complex scenes [23].

The use of testing intervals for pedestrian movement checks also contributed to improved performance. Instead of checking every frame for a pedestrian's destination, the system was configured to perform these checks at regular intervals, which lowered the computational demand without sacrificing the simulation's accuracy [23].

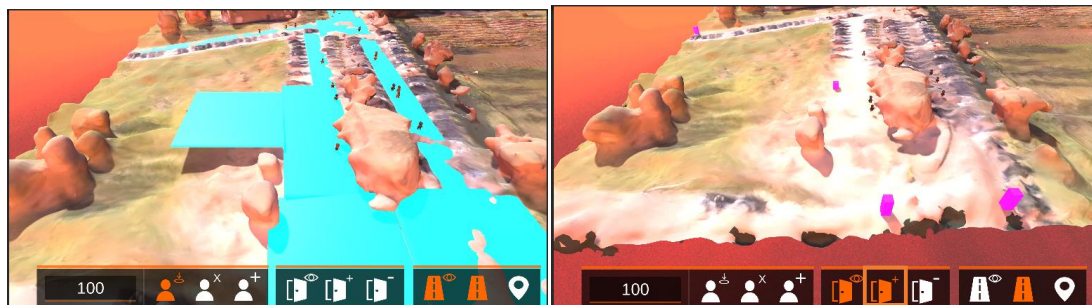

Figure 4 - Testing Pedestrian Movement.

EVALUATION AND RESULTS

The completed 3D model of the ESTIG campus was evaluated for realism, interactivity, and performance. The introduction of animated pedestrians and birds added life to the virtual environment, creating an immersive experience for users [25]. The use of Unity's NavMesh system proved effective in managing the automated movements of these elements within the environment [25].

Performance metrics, including frame rate and latency, were also measured. The medium-polygon model performed well under typical conditions, maintaining a steady frame rate even with the addition of animated elements [26]. Object pooling and occlusion culling further improved the overall system performance, allowing for real-time rendering of complex scenes [27].

CONCLUSIONS

This study demonstrates the potential of aerial photogrammetry in creating highly realistic 3D models. By integrating drone technology with advanced software tools like Unity and Luma, it was possible to create a dynamic and interactive virtual environment. The addition of animated elements enhanced the realism of the scene, while optimization techniques ensured that the system could perform efficiently in real time.

Future work could involve expanding the model to cover larger areas of the IPB campus and incorporating more complex animated elements, such as vehicles. This project provides a solid foundation for further exploration of 3D VR simulations in real-world applications [28][29].

REFERENCES

- Adams, L. "High-Polygon vs Medium-Polygon Models: A Performance Comparison." *Simulation Optimization Journal*, 2019.
- Anderson, C. "Expanding Drone Applications in Urban Planning." *Journal of Remote Sensing*, 2020.
- Base Aerofoto. "What is Aerial Photogrammetry?" *Base Aerofoto*, 2023.
- Brown, A. "The Future of 3D Animation and Modeling in Simulation Environments." *Journal of Game Design*, 2021.
- Clark, D. "Automating Character Movements Using Unity NavMesh." *Journal of Game Design*, 2018.
- DJI Mini 2 Manual. "DJI Mini 2: User Manual." DJI.
- Garcia, P. "Drone Mapping Techniques in Modern Civil Engineering." *Journal of Engineering Applications*, 2020.
- Garcia, L. "Performance Metrics in 3D Simulation." *Simulation Optimization Journal*, 2018.
- Green, D. "Using Drones for Virtual Reality Model Creation." *International Journal of Photogrammetry*, 2019.

- Millar, S. "Achieving Realism in 3D Virtual Models Using Unity." *Computers & Graphics Journal*, 2019.
- Smith, J. "UAVs in Environmental Monitoring." *International Journal of Remote Sensing*, 2019.
- Williams, H. "Challenges in Aerial Photogrammetry Using Drones." *Photogrammetry Journal*, 2021.
- Silva, R. "Drone-Based 3D Modeling in Virtual Reality." *Journal of Urban Simulation*, 2020.
- DJI Technologies. "DJI Fly App Guide." Available: <https://www.dji.com/fly>.
- Luma Labs. "Luma Capture: Overview." Luma AI, 2022.
- Thompson, G. "AI in Photogrammetry Processing." *AI in Simulation Journal*, 2020.
- Qureshi, A. "Unity and NavMesh for 3D Animation." *Journal of Game Development*, 2019.
- Godinho, P. "Drone Imagery and Its Application in 3D Mapping." *Remote Sensing Today*, 2021.
- Li, X. "Performance Optimization Techniques in 3D Simulations." *Journal of Digital Rendering*, 2021.
- Kim, S. "Challenges of Weather Conditions in Drone-Based Mapping." *International Journal of Photogrammetry*, 2022.
- Park, J. "Realistic Environmental Animation in VR." *VR in Practice*, 2020.
- Patel, A. "Improving Performance Through Object Pooling in Unity." *Journal of Virtual Simulation*, 2020.
- Rodriguez, L. "The Role of AI in Enhancing 3D Animations in Simulations." *Journal of Digital Design*, 2021.
- Roberts, S. "Photogrammetry in 3D Model Generation." *Computers & Graphics*, 2020.
- Rodriguez, M. "Object Pooling for Efficient Resource Management." *Game Engine Optimization Journal*, 2019.
- Thompson, H. "Evaluating Real-Time Rendering in Photogrammetric Models." *Journal of Simulation Engineering*, 2020.
- Unity Technologies. "NavMeshComponents." Available: <https://github.com/Unity-Technologies/NavMeshComponents>
- Walker, T. "Occlusion Culling in Complex Virtual Environments." *Journal of 3D Technologies*, 2020.
- Zheng, Y. "Interval-Based Testing for Animation Efficiency." *Computers & Animation Journal*, 2021.

A Review of Best Methods for 3D Scanning and Modeling of Terrain and Buildings Using Drones and Photogrammetry

L. D. Deusdado¹, J. Rocha¹

¹Instituto Politécnico de Bragança, 5300-253, Bragança, Portugal

(*)**Email:** leodeus@ipb.pt, jrocha@ipb.pt

ABSTRACT

Recent advancements in drone technology and photogrammetry have revolutionized the field of 3D terrain and building modelling. Drones equipped with photogrammetric software provide efficient, accurate, and cost-effective solutions for capturing high-resolution 3D models of both natural and urban environments. This literature review consolidates research on best practices for terrain and building scanning using drones and photogrammetry, focusing on methodologies, integration of technologies, challenges, and future directions. Additionally, the review explores applications in urban planning, environmental monitoring, disaster management, and heritage preservation.

Keywords: Drone Technology; Photogrammetry; 3D Modelling; Urban Planning.

INTRODUCTION

The rapid growth in the use of drones, also known as Unmanned Aerial Vehicles (UAVs), for 3D scanning and modelling has been transformative in numerous fields, from construction and urban planning to environmental science and archaeology. Photogrammetry, a well-established method for creating 3D models from 2D images, has benefited immensely from drone technology, as drones can capture aerial imagery quickly, accurately, and at relatively low costs compared to traditional methods like terrestrial laser scanning and LiDAR (Light Detection and Ranging).

The advantages of UAVs combined with photogrammetry are numerous, particularly in terms of flexibility, scalability, and cost. Unlike ground-based methods, drones can easily cover large, hard-to-access areas, capturing images from different angles to create detailed 3D reconstructions. This literature review aims to synthesize current research and best practices in drone-based photogrammetry, while exploring both its potential and limitations in various real-world applications.

TECHNOLOGICAL FOUNDATIONS OF 3D SCANNING USING DRONES AND PHOTOGAMMETRY

Photogrammetry

Photogrammetry is a method used to obtain reliable measurements from images, typically photographs. The science behind photogrammetry involves using geometric relationships

between image points to calculate 3D coordinates. Historically, photogrammetry has been used in cartography, but the integration of photogrammetric techniques with drone technology has opened new possibilities for 3D terrain modelling and architectural reconstructions [1].

Key methods in photogrammetry include:

- **Structure-from-Motion (SfM):** A technique that aligns multiple overlapping images to reconstruct a scene in 3D by computing the camera position and orientation.
- **Multi-View Stereo (MVS):** A complementary technique to SfM, used to densify the sparse point clouds produced by SfM, enabling the generation of high-resolution 3D models.

LiDAR vs. Photogrammetry

LiDAR and photogrammetry are often compared in terms of their suitability for different types of 3D modelling projects. LiDAR uses laser pulses to measure distances, making it particularly effective for capturing precise terrain data, even in dense vegetation or low-light conditions. Photogrammetry, in contrast, relies on images captured from multiple angles, making it better suited for high-detail visual models.

However, LiDAR systems are significantly more expensive than photogrammetry, and photogrammetry is usually preferred for large-scale projects that do not require the ultra-high precision that LiDAR provides [2].

Technology	Strengths	Weaknesses
LiDAR	High precision; effective in low-light or dense vegetation	High cost; complex data processing
Photogrammetry	Lower cost; can generate highly detailed visual models	Sensitive to lighting conditions; less effective in dense vegetation

Drones in Photogrammetry

Drones are equipped with cameras and, in some cases, additional sensors such as GPS and Inertial Measurement Units (IMUs), which help in determining the exact position and orientation of the images taken. This combination allows drones to collect detailed, georeferenced data that can be processed into 3D models using photogrammetric software.

Drones can fly predefined routes, capturing images with consistent overlap and coverage, which is essential for building accurate models. Many modern drones are also equipped with high-resolution cameras that significantly improve the quality of the final model.

Key elements of a successful drone-based photogrammetry project include:

- **Flight planning:** Determining the optimal altitude, camera angle, and image overlap to capture all necessary details.

- **Data acquisition:** Ensuring the images are captured under appropriate lighting and weather conditions to avoid distortions such as shadows or glare.
- **Processing software:** Using tools such as Pix4D, Agisoft Metashape, or OpenDroneMap to process the images into a 3D point cloud.

BEST PRACTICES IN 3D SCANNING OF TERRAIN AND BUILDINGS

Data Acquisition Techniques

The data acquisition stage is perhaps the most crucial in the entire photogrammetric process, as it directly impacts the accuracy and quality of the final model. Several factors must be considered, including flight altitude, image overlap, and weather conditions.

Studies have shown that flight altitude directly affects the level of detail captured, with lower altitudes resulting in more detailed models. However, this must be balanced against the area that can be covered in a single flight. Image overlap should typically be 60-80% to ensure that sufficient points of interest are captured in multiple images, enabling the photogrammetry software to reconstruct the 3D model [3] accurately.

Additionally, lighting conditions can have a significant impact on the quality of the images captured. Overcast conditions are often ideal for aerial photography as they reduce harsh shadows that can interfere with the photogrammetric process. Poor lighting, on the other hand, can result in blurry or low-contrast images, which will affect the accuracy of the model.

Image Processing and Photogrammetry Software

Once data has been acquired, the next step is image processing, which involves turning the 2D images into a 3D point cloud. This process is typically carried out using specialized photogrammetry software such as Agisoft Metashape, Pix4D [4], or DroneDeploy.

The most widely used algorithm for this purpose is Structure-from-Motion (SfM), which aligns the images by identifying common points across multiple images. This results in a sparse 3D point cloud, which can be densified using Multi-View Stereo (MVS). The final point cloud is then used to generate a textured 3D mesh, which can be further processed for visualization or analysis.

CHALLENGES IN DRONE-BASED PHOTOGRAMMETRY

Despite its many advantages, drone-based photogrammetry is not without its challenges. The primary issues relate to the accuracy of the models generated and the time required for processing. Environmental factors, such as the presence of reflective surfaces (e.g., water bodies) or dense vegetation, can distort the final models. Similarly, poor lighting conditions, such as excessive shadows or glare, can negatively impact the quality of the data collected [5].

Another significant challenge is processing time. While photogrammetry has made significant strides in reducing the time required to process large datasets, it remains a time-consuming process, particularly for large areas or highly detailed models. Recent advancements in cloud computing have alleviated some of these issues, allowing for faster processing of large datasets [6].

APPLICATIONS IN TERRAIN AND BUILDING MODELING

Urban Planning and Architecture

Drones and photogrammetry have found significant applications in urban planning and architecture, where accurate and detailed 3D models of buildings and landscapes are needed. Drones can capture high-resolution images of urban environments, which can then be processed into 3D models for use in architectural design, building inspections, and infrastructure planning [7].

In particular, Building Information Modeling (BIM) has benefited from the use of drones, allowing for the integration of detailed 3D models into larger datasets that can be used to monitor construction progress or simulate the effects of new developments on the surrounding area.

Environmental Monitoring and Disaster Management

Drones have also become indispensable tools for environmental monitoring, where they are used to map landscapes, monitor vegetation growth, and assess land-use changes. In disaster management, drones equipped with photogrammetric capabilities can quickly capture images of affected areas, allowing for the creation of detailed 3D models that can be used to assess damage and plan recovery efforts [8].

RECENT ADVANCES AND FUTURE TRENDS

Autonomous Drones and AI Integration

One of the most promising recent developments in drone photogrammetry is the integration of artificial intelligence (AI) and autonomous drones. AI-driven drones can fly autonomously, without the need for a human operator, which reduces the time and effort required to capture large areas. These drones can also make real-time decisions, such as adjusting their flight paths to avoid obstacles or changing weather conditions [9,10]. In addition, AI is being used to improve the accuracy of photogrammetric models by automating the feature extraction process, reducing the need for manual intervention.

Cloud Computing and Real-Time Processing

The use of cloud computing in photogrammetry has also expanded rapidly. Cloud-based platforms such as DroneDeploy and Pix4D Cloud allow users to upload their data for processing, eliminating the need for powerful local hardware. These platforms can process data quickly and return results in real-time, which is particularly useful in time-sensitive applications such as disaster management.

CONCLUSION

Drone-based photogrammetry offers numerous advantages for 3D terrain and building modeling, providing a flexible, cost-effective, and scalable solution for capturing detailed 3D models. While challenges such as environmental factors and processing times remain, advances in AI, autonomous drones, and cloud computing promise to address these issues and further expand the capabilities of photogrammetry. As technology continues to evolve, drone-based 3D

scanning is likely to become even more integral to fields such as urban planning, environmental monitoring, and disaster management.

REFERENCES

- Casella, E., Rovere, A., Pedroncini, A., Stark, C. P., Casella, M., Ferrari, M., & Firpo, M. (2016). Drones as tools for monitoring beach topography changes in the Ligurian Sea (NW Mediterranean). *Geo-Marine Letters*, 36(3), 151-163.
- Colomina, I., & Molina, P. (2014). Unmanned aerial systems for photogrammetry and remote sensing: A review. *ISPRS Journal of Photogrammetry and Remote Sensing*, 92, 79-97. <https://doi.org/10.1016/j.isprsjprs.2014.02.013>
- Eisenbeiss, H. (2009). UAV photogrammetry (Doctoral dissertation). ETH Zurich. <https://doi.org/10.3929/ethz-a-005939264>
- Kraus, K. (2007). *Photogrammetry: Geometry from Images and Laser Scans*. Walter de Gruyter.
- Nex, F., & Remondino, F. (2014). UAV for 3D mapping applications: A review. *Applied Geomatics*, 6(1), 1-15. <https://doi.org/10.1007/s12518-013-0097-8>
- Pix4D. (2020). Photogrammetry software for drone mapping. Retrieved from <https://www.pix4d.com>
- Rinaudo, F., Chiabrando, F., Lingua, A., & Spanò, A. T. (2012). Archaeological site monitoring: UAV photogrammetry can be an answer. *International Archives of the Photogrammetry, Remote Sensing and Spatial Information Sciences*, 39, B5.
- Turner, D., Lucieer, A., & Watson, C. (2012). An automated technique for generating georectified mosaics from ultra-high resolution unmanned aerial vehicle (UAV) imagery, based on Structure from Motion (SfM) point clouds. *Remote Sensing*, 4(5), 1392-1410. <https://doi.org/10.3390/rs4051392>
- Wallace, L., Lucieer, A., Malenovský, Z., Turner, D., & Vopěnka, P. (2016). Assessment of forest structure using two UAV techniques: A comparison of airborne laser scanning and structure from motion (SfM) point clouds. *Forests*, 7(3), 62. <https://doi.org/10.3390/f7030062>
- Westoby, M. J., Brasington, J., Glasser, N. F., Hambrey, M. J., & Reynolds, J. M. (2012). 'Structure-from-Motion' photogrammetry: A low-cost, effective tool for geoscience applications. *Geomorphology*, 179, 300-314. <https://doi.org/10.1016/j.geomorph.2012.08.021>

Mechanical analysis of specimens generated by 3D topological optimization

F Y M Stein, J Rocha, M Araújo, J Santos

Instituto Politécnico de Bragança, 5300-253, Bragança, Portugal

(*)*Email:* felipe.stein@ipb.pt

ABSTRACT

This study investigates the use of topologically optimized filling in additive manufacturing to enhance the strength-to-mass ratio of 3D printed parts. The research utilized SolidWorks modeling, adhering to the ASTM 695-15 standard, with optimization focused on various symmetries and preserved regions to maximize structural efficiency. The specimens were printed using Anycubic Kobra 2 Neo 3D printers and ABS filament, and the optimized models were compared to those with standard fillings (grid and triangular) through compression testing. The results showed that while the optimized filling achieved only 50% of the strength of the standard-filled models, the grid pattern outperformed the others, demonstrating superior performance and ductility. Ultimately, the study concluded that the optimization process did not surpass the performance of the standard meshes generated by 3D printing slicers.

Keywords: Topologically optimized filling; Additive manufacturing; Strength-to-mass ratio; Compression testing.

CONTEXT

Additive manufacturing has seen growing adoption in industry, both for prototyping and for the production of commercial parts intended for final products (Gibson, Rosen, & Stucker, 2015; Deckard & Beaman, 1988). Topological optimization, which employs finite element analysis to minimize part mass without compromising mechanical strength, is often constrained by manufacturing methods. However, this limitation can be alleviated through the use of 3D printing technologies (Dassault SolidWorks, 2018). This technique has been successfully applied in the automotive industry, particularly in high-performance vehicles, where reducing weight and enhancing structural efficiency are critical (Porsche, 2023).

To further optimize the analysis of models before printing, this study proposes replacing the standard infill patterns with a topologically optimized fill. This approach aims to improve the strength-to-mass ratio of the printed parts, enhancing their overall performance.

MATERIAL AND METHODS

This section discusses the methods used in the study to replace the standard 3D printing filler with the filler generated by topological optimization.

Modeling

The model was designed using SolidWorks software, following the ASTM 695-15 standard (ASTM, 2015), with dimensions set at twice the size recommended by the standard (Figure 1). The solid model (Figure 2) was used as the foundation for both slicing the parts with standard filling and for performing the topological optimization.

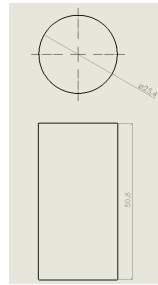

Figure 1 - Model dimensions.

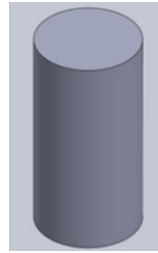

Figure 2 - Solid model.

Optimization

For the optimization stage, on Solidworks, the boundary conditions were defined, and a mesh element of 0.5 mm in length was applied. This mesh configuration resulted in a total of 591,107 elements and 108,256 nodes, producing a mesh similar to the one illustrated in Figure 3.

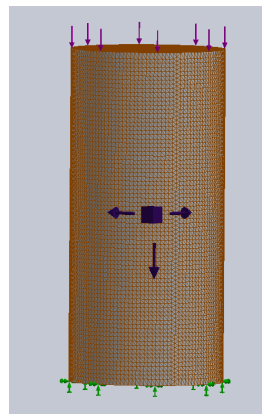

Figure 3 - Generated mesh.

Regarding symmetry, an analysis of various symmetry planes was conducted to evaluate the impact of symmetry restrictions on mass distribution. The analysis began without any symmetry, followed by the application of $\frac{1}{2}$ symmetry (Figure 4), $\frac{1}{4}$ symmetry (Figure 5), and finally $\frac{1}{8}$ symmetry, as depicted in Figure 6.

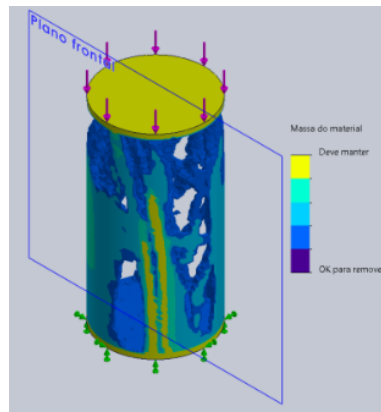

Figure 4 - 1/2 symmetry model.

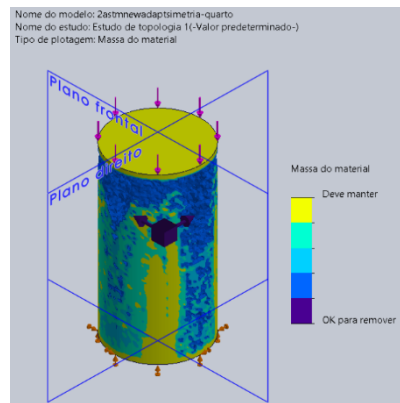

Figure 5 - 1/4 symmetry model.

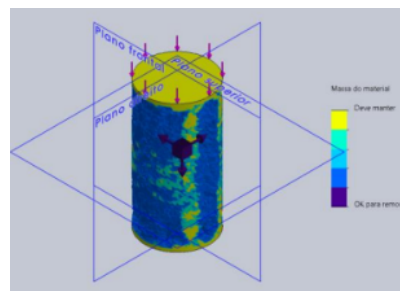

Figure 6 - 1/8 symmetry model

Next, the preserved region constraint was added, and the outer face of the model was selected, resulting in an optimized model as shown in Figure 7 and Figure 8.

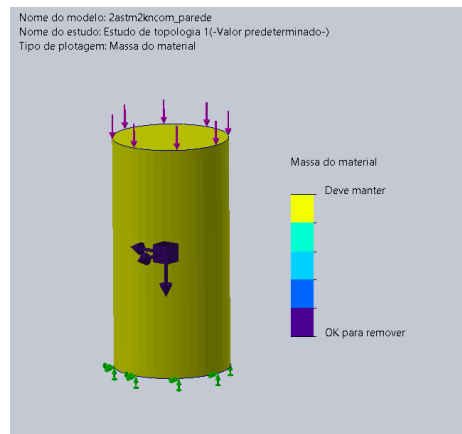

Figure 7 - Model with preserved region.

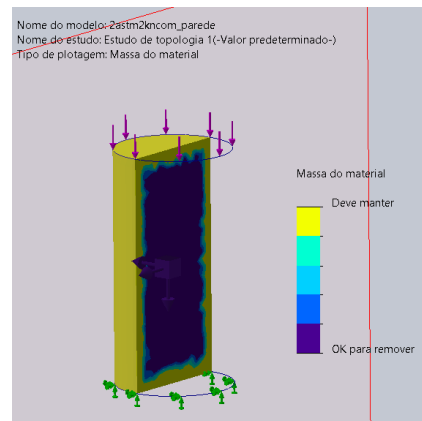

Figure 8 - Section of the model with preserved region.

Slicing

The topologically optimized models were imported into Ultimaker cura software, version 5.5.0, where they were sliced, converting the 3d objects into g-code format. This process allowed the mass of the specimens to be determined, which was 10 g. After this check, the standard specimens were sliced using the grid and triangular filling patterns in order to obtain the same mass of 10 g, so as to compare the strength of the different filling geometries equally.

Printing the specimens

The specimens were 3d printed using an anycubic kobra 2 neo printer, in which an encapsulation was adapted so that abs printing was possible. By encapsulating and printing one specimen at a time, it was possible to ensure that the specimens had no printing defects, such as the top and bottom of the specimens not being parallel or the layers not adhering to each other.

Compression test

The compression test was carried out on a shimadzu universal testing machine, which has a 10 kn load cell (figure 9). The test followed the recommendations of the ASTM 695-15 standard (ASTM, 2015), using a test speed of 1.3 mm/min, which was increased to 6 mm/min after the material had flowed.



Figure 9 - Universal testing machine.

RESULTS AND DISCUSSIONS

This section presents the results of the tests conducted on the 3D printed samples, comparing those with standard filling and those with optimized filling.

Compression test

The compression test results, shown in Figure 10, reveal that, despite having the same mass, the specimens with topologically optimized filling exhibited only 50% of the resistance compared to the specimens with standard filling (both grid and triangular).

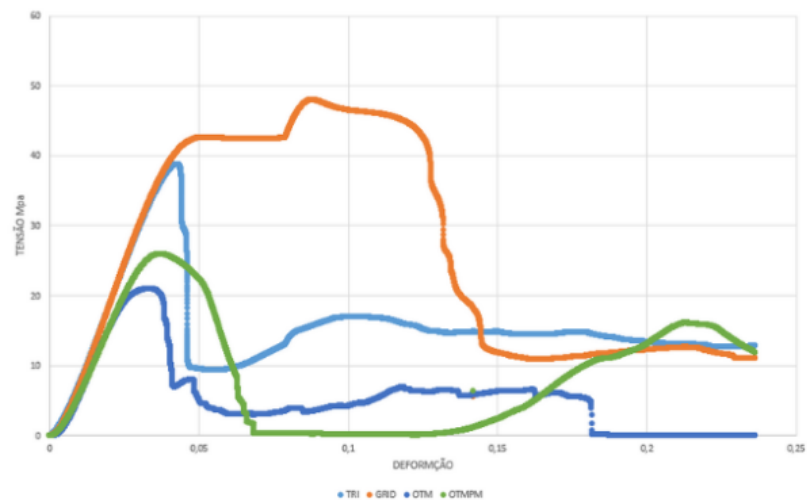

Figure 10 - Test results.

The results also indicate that the grid pattern outperformed all other specimens in terms of performance. In contrast, the triangular pattern exhibited a more brittle failure, likely due to its truss structure, which restricts the movement of the planes and compromises its overall durability.

CONCLUSIONS

The study revealed that topologically optimized parts, despite withstanding loads up to five times greater than their design capacity, were unable to outperform parts with standard infill patterns. This was attributed to the optimized parts' lower force distribution efficiency compared to the mesh structures provided by standard infills.

For future research, it would be valuable to examine the impact of adding an external wall to the optimized parts and to explore a gradual mass reduction strategy, testing reductions at 10%, 20%, 30%, and 40% to avoid abrupt mass loss. Additionally, analyzing more complex components by comparing topologically optimized parts with original parts using standard infills but of equal mass would provide further insights into the performance differences between these structures.

REFERENCES

- ASTM. (2015). *Standard test method for compressive properties of rigid plastics. Designation: D695-15*. ASTM International.
- Dassault SolidWorks. (2018). *Projeto por meio de análise: melhorar o projeto do produto e automatizar a fabricação com otimização de topologia*. Dassault Systèmes.
- Deckard, C., & Beaman, J. (1988). Process and control issues in selective laser sintering. *Journal of Materials Processing Technology*, 76(1-3), 72-79.
- Gibson, I., Rosen, D., & Stucker, B. (2015). *Additive manufacturing technologies*. Springer. <https://doi.org/10.1007/978-1-4939-9810-7>
- Porsche. (2023). 3D printing technology optimises pistons for the powerful 911 GT2 RS. *Porsche Newsroom*. <https://www.porsche.com/newsroom/en/press-releases/2023/03/3d-printing-technology-optimises-pistons-for-the-powerful-911-gt2-rs/>

The Role of Artificial Intelligence in Personalizing the Traveler Experience

I M Lopes^{1,2,3*}, P Oliveira¹

¹Instituto Politécnico de Bragança, 5300-253, Bragança, Portugal

²UNIAG, Instituto Politécnico de Bragança, Campus de Santa Apolónia, 5300-253 Bragança, Portugal

³CeDRI, Instituto Politécnico de Bragança, Campus de Santa Apolónia, 5300-253 Bragança, Portugal

(*)*Email:* isalopes@ipb.pt

ABSTRACT

The industry that is thought to have profited most from technical advancement is tourism. One notable example of this breakthrough in the past ten years is artificial intelligence (AI), which has become a vital instrument that can drastically alter the experience of visitors. Artificial Intelligence (AI) is revolutionizing travel planning, booking, and experience with chatbots providing round-the-clock customer support and personalized recommendation systems suggesting locations, activities, and places to visit. AI is there prior to, during, and following the excursion. The purpose of this study is to investigate existing technologies, their advantages and disadvantages, and the effects of their implementation in the tourist sector. Specifically, it looks at how AI can be used to personalize the passenger experience. In addition to using state-of-the-art techniques, these results are also obtained by administering a questionnaire to tourists in order to get a specific, quantitative response. Furthermore, the study's limitations are discussed and recommendations for further research are made.

INTRODUCTION

AI has been a part of tourism from the automated reservation system's initial applications. Significant advancements have been made recently, as the development of increasingly sophisticated tools, including chatbots and recommendation systems, has been made possible by the advent of machine learning algorithms and natural language processing (Gonçalves, M., 2023).

Customer service chatbots: Chatbots are computer programs designed to mimic human-to-human discussions and are utilized to offer customer care in real time. According to studies, chatbots can answer a variety of consumer concerns, from straightforward ones like check-in times to more complicated ones, thereby improving productivity and client happiness.

Personalized Recommendation Systems: Recommendation engines make relevant product and service recommendations based on user data. Within the tourism industry, these systems use data like as past travel experiences, expressed interests, and internet activity to recommend vacation locations, lodging options, and activities that best fit the traveler's profile.

In the tourism industry, artificial intelligence is changing conventional methods and opening up new prospects. Businesses that use AI will be more competitive because they can provide efficient and customized experiences.

"The broad adoption of AI across various market applications, such as demand forecasting, big data analysis, and automation and robotics in the hotel industry" (dos Santos et al, 2024) is acknowledged by the scientific literature in the tourism sector.

RESULTS

The questionnaires were distributed in hotels to tourists between September 4th and October 2nd, 2023 in the city of Bragança, Portugal. The total number of responses was 156.

Upon gathering demographic data in the first section, it was discovered that 10 of the individuals were under the age of 18, 20 were between the ages of 18 and 24, 47 were between the ages of 25 and 34, 53 were between the ages of 35 and 44, 21 were between the ages of 45 and 54, 3 were between the ages of 55 and 64, and 2 were 65 or older. It leads us to the conclusion that the respondents' age range is quite young.

103 (66%) of the respondents were men, 46 (29%) were women, and 7 (5%) indicated they were unsure.

84 people identify as Portuguese, 29 as Spanish, 15 as United Kingdom, 14 as French, 12 as Brazilians, and 2 as Germans.

The first question on the questionnaire asked about the kind of AI services you utilized while traveling; the responses are shown in Fig. 1 below. The second section of the questionnaire concentrated on the experience with AI services in tourism.

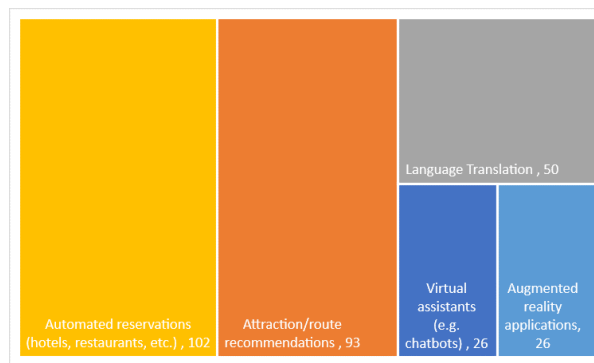

Fig. 1. Type of AI services used during the trip.

Respondents to this question had the option of selecting more than one choice; the following findings are shown in descending order in Fig. 1: reservations made automatically I was given 102 options, 93 suggestions for sites or routes, 50 responses for language translation, and an equal number of responses for the usage of augmented reality and virtual assistants.

When asked how often they use AI services in their travels, of the 156 respondents, 58 responded that they use AI services in their travels frequently, 40 responded occasionally, 32 rarely, and 26 responded that they always use these services.

When respondents were asked about the level of personalization provided by AI services, the answers were not very positive in relation to this question. 68 of the respondents responded that the level of personalization was low, 54 very low, 29 moderate, 3 high and 2 responded that it was very high.

When asked to what extent AI services improve their travel experience. As can be seen, the majority of comments are very good. Of the respondents, 98 said that the improvements were significant, and 50 said that their trip was significantly improved by using this service. Merely 8 out of those polled said their experience had not changed much.

CONCLUSIONS

Travelers are generally delighted with chatbot services, which have a high success rate of resolving issues without the need for human intervention, according to the results of utilizing chatbots in customer care. Additionally, it was shown that businesses who successfully integrated chatbots had a considerable rise in consumer satisfaction. With a noticeable rise in user engagement, the adoption of personalized recommendation systems produced highly accurate and pertinent results. Travelers who followed these suggestions spoke of more individualized and fulfilling trips.

AI has many advantages, such as comprehensive insights into visitor behavior, operational efficiency, and customisation. It does, however, confront obstacles including privacy issues, the requirement for substantial amounts of precise data, and the difficulty of putting complex systems into practice.

During the investigation, limitations of the study were discovered, including sample size and potential biases in the respondents' answers.

Future studies can examine how AI affects various tourist demographics and how new technologies are developed and used in the travel industry.

REFERENCES

Gonçalves, M.: A Inteligência Artificial e a Formação (2023). <https://psicosoma.pt/novidades/a-inteligencia-artificial-e-a-formacao/>, last accessed 2024/06/01.

dos Santos V.S., de Sousa S.J.A., Santos L.M.L., Filho L.A.M.M., Porte M.S., Taveira M.D.S., Alexandre M.L.O.: Artificial intelligence in Tourism studies and re-search in Brazil, *Brazilian Journal of Tourism Research*, 18 (1) (2024).

Acceptance and familiarization with Wearable Devices in Portugal and Brazil

I M Lopes^{1,2,3*}, J Rocha¹, P Oliveira¹

¹Instituto Politécnico de Bragança, 5300-253, Bragança, Portugal

²UNIAG, Instituto Politécnico de Bragança, Campus de Santa Apolónia, 5300-253 Bragança, Portugal

³CeDRI, Instituto Politécnico de Bragança, Campus de Santa Apolónia, 5300-253 Bragança, Portugal

(**Email:* isalopes@ipb.pt)

ABSTRACT

This research sought to understand the acceptance of wearable devices in Portugal and Brazil, analyzing aspects such as demographic profiles, experiences with technology and personal perceptions. An adaptation of the UTAUT2 model was made, obtaining responses from university students and frequent internet users through a questionnaire that used the Likert scale. The evaluation of the data indicated a predominance of participants from Portugal, a tendency for acceptance to be more pronounced among younger people, those with a higher level of education and a greater technological proficiency among men and more qualified individuals. The relationship between users and non-users of wearable devices proved to be balanced, with a more marked acceptance by people aged 35 to 59, women and those who have a positive view of technology. The Smartwatch stood out among the devices, followed by the Fitness Bracelet and the Smart Ring. A variation in social influence was observed according to the type of device, being more striking in the case of Smartwatches. Surprisingly, social influence did not prove to be as crucial in the acceptance of wearable devices as initially thought. The findings show a trend towards the adoption of these devices, while also warning of challenges linked to the perceived value and price of products, signaling an area with great potential for future research and innovation.

INTRODUCTION

The rapid spread of wearable technologies over the past decade, ranging from connected watches to smart clothing and fitness monitoring devices, requires a detailed examination of the consequences it brings to society and the individual (Ferreira et al., 2022). This progress in the field of technology has not been limited to transforming aspects of everyday life, but has also found its way into business procedures and routines. Thus, given their trajectory of growth and social relevance, it is imperative to evaluate both the positive aspects and the possible obstacles associated with these gadgets. Wearables emerge as catalysts for a new era in health monitoring and communication, enabling not only the tracking of health metrics, but also rapid interaction via messages and precise location via GPS. Autonomy of use, eliminating the need for constant handling, combined with portability, stands out as one of their greatest attractions, redefining the standards of practicality and access to information (da Silva & Vita, 2022). However, before the popularization of wearables, many of the features now offered by these devices were already accessible, albeit in a more limited way and dependent on less portable and practical equipment. Wearables revolutionize this scenario by promoting fluid interconnection with other smart devices, ensuring consolidation and easy access to information, whether for immediate consultation or future analysis.

RESULTS

Mastery and familiarity with electronic devices are increasingly central to contemporary life, and are a crucial skill for integration into the digital society. Based on the data collected, it is possible to draw an overview of the level of experience of respondents regarding their relationship with electronic devices.

The responses show that a majority of the sample, 55% of respondents, identify as intermediate, that is, they have had contact with electronic devices but do not consider themselves experts. The category of experts, which represents those who have extensive experience with different types of devices, makes up 44% of the sample. On the other hand, only 1% of respondents indicated that they had never used electronic devices, categorizing themselves as beginners.

This mostly intermediate or expert profile demonstrates a high degree of familiarity with technologies, which is expected in an increasingly connected society.

Geographic location: The average familiarity with electronic devices in Portugal is slightly higher than in Brazil, with an average of 2.49 and 2.26, respectively. Both locations, however, have the mode and median positioned at 2, indicating that the "intermediate" category is the most frequent.

Age range: It is noted that the 17 to 24 age group shows a tendency to identify themselves as experts, with a mode and median at 3. This may suggest that the younger generations, who grew up in a more digitalized environment, are more familiar with electronic devices. On the other hand, as age advances, a decreasing trend is observed in the average, indicating a more Intermediate profile among the 25 to 59 age groups.

Gender: Men, with a mode and median at 3, are more inclined to categorize themselves as experts compared to women, whose respective measures are 2 (intermediate).

Education: Those in higher education tend to categorize themselves as experts, with a mode and median of 3 and a mean of 2.51. This pattern is similar for those with postgraduate degrees, with a mean of 2.40. On the other hand, individuals with a higher education degree tend to identify themselves as intermediate, with a mean of 2.18.

In summary, the data suggest that most respondents have an intermediate or advanced level of familiarity with electronic devices. The relationship between familiarity with devices and variables such as geographic location, age range, gender, and level of education offers valuable insights into the nuances of technology integration across different segments of the population.

CONCLUSIONS

The present investigation into the acceptance of wearable devices in Portugal and Brazil, as outlined in the results, provided a comprehensive understanding of the dynamics that influence the adoption of these technologies. The data collected highlighted a predominant profile of young users, located mainly in Portugal, and with a high level of education, suggesting a correlation between youth, education and the acceptance of wearables. This trend reinforces the idea that familiarity and comfort with technology, often associated with younger age groups and well-educated individuals, play a crucial role in the willingness to adopt new devices.

The general acceptance of wearables among participants suggests a positive trend towards the adoption of these technologies. However, the results also highlight significant challenges,

particularly in relation to the perceived value and price of the devices. This is a crucial aspect, since value for money plays a fundamental role in consumers' purchasing decisions. The prominent preference for Smartwatches, followed by Fitness Bracelets and Smart Rings, points to a hierarchy in user preferences, which seems to be influenced by the perceived usefulness and functionality of the devices.

REFERENCES

Ferreira, P. N., Beda, J. L., Belarmino, G. D., Rodriguez, C. L., & Motti, V. G. (2022, November). Movimentação de Aluno em Sala de Aula: Análise Descritiva de Dados de Wearables. In Anais do I Workshop de Aplicações Práticas de Learning Analytics em Instituições de Ensino no Brasil (pp. 69-78). SBC. <https://sol.sbc.org.br/index.php/wapla/article/view/22524>

da Silva, F. F., & Vita, J. B. (2022). Wearables, telemedicina e futuro da saúde no Brasil: Novas tendências em tecnologias de saúde para enfrentamento de pandemias. *Humanidades & Inovação*, 9(19), pp. 195-211. <https://revista.unitins.br/index.php/humanidadeseinovacao/article/view/5608>